

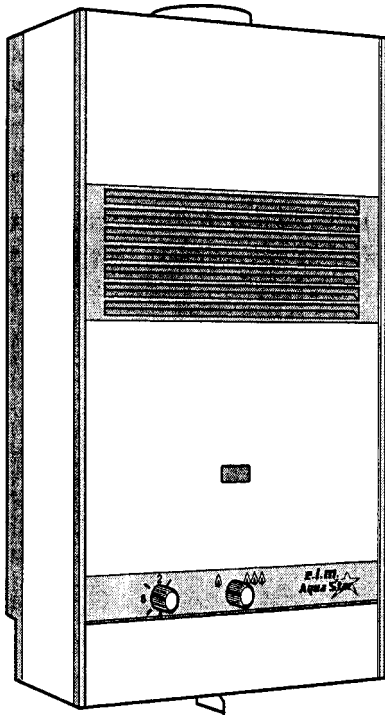

**INSTALLATION AND OPERATING INSTRUCTIONS  
FOR AUTOMATIC INSTANTANEOUS TYPE WATER HEATERS  
FOR USE WITH NATURAL AND LIQUEFIED PETROLEUM GAS**

**MODEL 80 VP AND MODEL 80VPS  
Suitable for water (potable) heating and space heating**

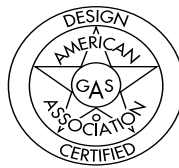

**WARNING:** If the information in this manual is not followed exactly, a fire or explosion may result causing property damage, personal injury or death.

**FOR YOUR SAFETY**

Do not store or use gasoline or other flammable, combustible or corrosive vapors and liquids in the vicinity of this or any other appliance.

**WHAT TO DO IF YOU SMELL GAS**

- Do not try to light any appliance.
- Do not touch any electrical switch; do not use any phone in your building.
- Immediately call your gas supplier from a neighbor's phone. Follow the gas supplier's instructions.
- If you cannot reach your gas supplier, call the fire department.

**- Installation and service must be performed by a qualified installer, service agency or the gas supplier.**

Upon completion of the installation, these instructions should be handed to the user of the appliance for future reference. **\*REPLACEMENT MANUAL MUST BE PURCHASED**

**FEATURING:** Variable Power - Modulating Gas Valve - Thermostatic Control with Temperature Dial Selector

## TABLE OF CONTENTS

Specifications .....	Page	3
Rules for Safe Operation .....	Page	4-5
General Overview of Aquastar .....	Page	6
Locating the Heater for Safe Proper Combustion.....	Page	7
Installation .....	Page	8
Connecting Gas and Water Lines & Pressure Relief Valve .....	Page	9-10
Vent Pipe Connection .....	Page	10
Safety Before Lighting .....	Page	11
Lighting Instructions .....	Page	11
Setting Water Temperature .....	Page	12
Maintenance & Service .....	Page	12-14
Trouble Shooting .....	Page	14-18
Cleaning Pilot Assembly .....	Page	19
Calibration and Thermostat Test.....	Page	20-21
Description of Operation and Parts Layout Diagrams .....	Page	22-26
Gas Line Size, Vent Size & Height Guide Lines .....	Page	27

**This well engineered, tankless gas water heater has all the features a water heater should have:**

The instantaneous principle of heating water is very simple. Cold water enters the heater when a hot water faucet is opened. This flow of water causes the gas valve to open. Gas flows to the burners and is ignited by the pilot flame. The heat exchanger then absorbs the heat generated by the burners and transfers it to the cold water as it travels through the heat exchanger. When the hot water is turned off, the gas valve automatically closes and the burners shut off. Your hot water faucet is an ignition key for hot water. You now have complete control over your hot water energy use. [See pages 22-26 for detailed Description of Operation and Parts Layout Diagrams].

### FEATURES

- Automatic thermostatic control for steady hot water temperature. Burner output is proportional to water flow for maximum energy efficiency.
- Automatic thermostatic control for steady hot water temperature.
- Safety thermocouple at pilot and burner.
- Automatic Energy Cut-Off mechanism.
- Built-in gas shut-off valve.
- Stainless steel burners with stabilized blue flame.
- Built-in corrosion resistant draft inducer.
- Long working life insured by heavy-duty high quality materials.
- Compact space saver: mounts on wall with four screws.
- Easy installation.
- 2.2 gpm (removable) flow restrictor to ensure water flow will never exceed heater capacity.

**AquaStar 80 VP and 80 VP "S" Specifications:**

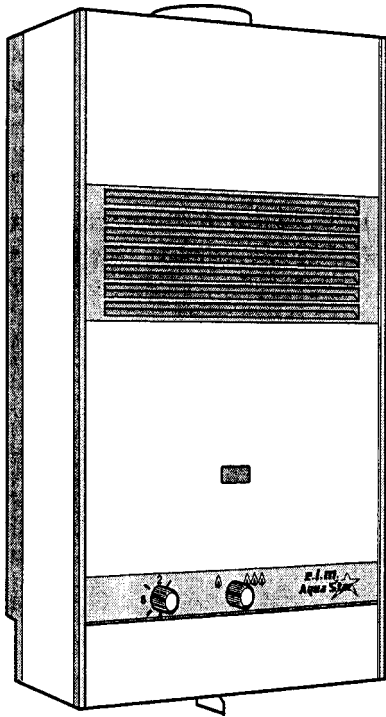

Gas input.....max: 77,500 Btu  
 min: 25,000 Btu  
 Water Connection.....1/2" sweat fitting  
 H x W x D.....27" x 12" x 9"  
 Vent.....4"  
 Gas Connection.....3/4" NPT thread  
 Min. Water Pressure.....15 Psi  
 Max. Water Pressure.....150 Psi  
 Shipping Weight.....33 lb  
 Net Weight.....27 lb  
 GPM at 90°F rise.....1.32\*  
 GPM at 45°F rise.....2.64\*  
 Min. Water Flow.....3/4 gal/min  
 LP GAS Pressure inlet.....min.: 10"W.C. \*\*\*  
 max.: 14"W.C. \*\*  
 LP GAS Manifold pressure.....8.9" W.C.  
 Natural Gas Pressure inlet.....min.: 4.7"W.C. \*\*\*  
 max.: 14"W.C. \*\*  
 Natural Gas Manifold Pressure.....3.2"W.C.

\* Figured on a 55°F cold inlet temperature  
 \*\* Inlet gas pressure must not exceed this value  
 \*\*\*For purposes of input adjustment

**SETTING THE INLET GAS PRESSURE FOR HIGH ALTITUDES**

The pressure regulator provided with the heater is set to deliver the proper gas pressure (as indicated on the rating plate and in the manual) for altitude up to 2500 feet (758 meters) above sea level. On appliances being installed above 2500 ft/ 758 m elevation, the inlet gas pressure should be reset at installation to the value shown below for the altitude of the installation.

**NOTE: The gas pressures specified below refer to pressures taken at the test pressure nipple on the manual gas valve as shown in fig.3 page 9. These readings should be taken while the heater is operating at full output --i.e. maximum water flow with the temperature setting on #8.**

MAXIMUM INLET GAS FLOW PRESSURE SETTING		
ALTITUDE	NATURAL GAS inches W.C.	LIQUID PROPANE inches W.C.
0' - 2,500 FT / 758 M	3.90"	9.75"
2,500 ft - 4,000ft / 758m - 1212m	3.00"	7.35"

**CAUTION: RULES FOR SAFE OPERATION**

If you are using the AquaStar for combined space heating and potable water heating (see *schematic diagram below*), all piping and other components connected to the system must be suitable for potable water, (b) toxic chemicals such as those commonly used for boiler treatment to prevent corrosion and freezing must not be introduced into the system, and (c) if the space heating requires water temperatures higher than those required for domestic, potable water, a mixing valve or other similar device must be provided to reduce scald hazard potential. **DO NOT CONVERT AN EXISTING, CLOSED HOT WATER HEATING SYSTEM TO A COMBINATION SPACE AND POTABLE WATER HEATING SYSTEM USING THE AQUASTAR OR ANY OTHER HEAT SOURCE.**

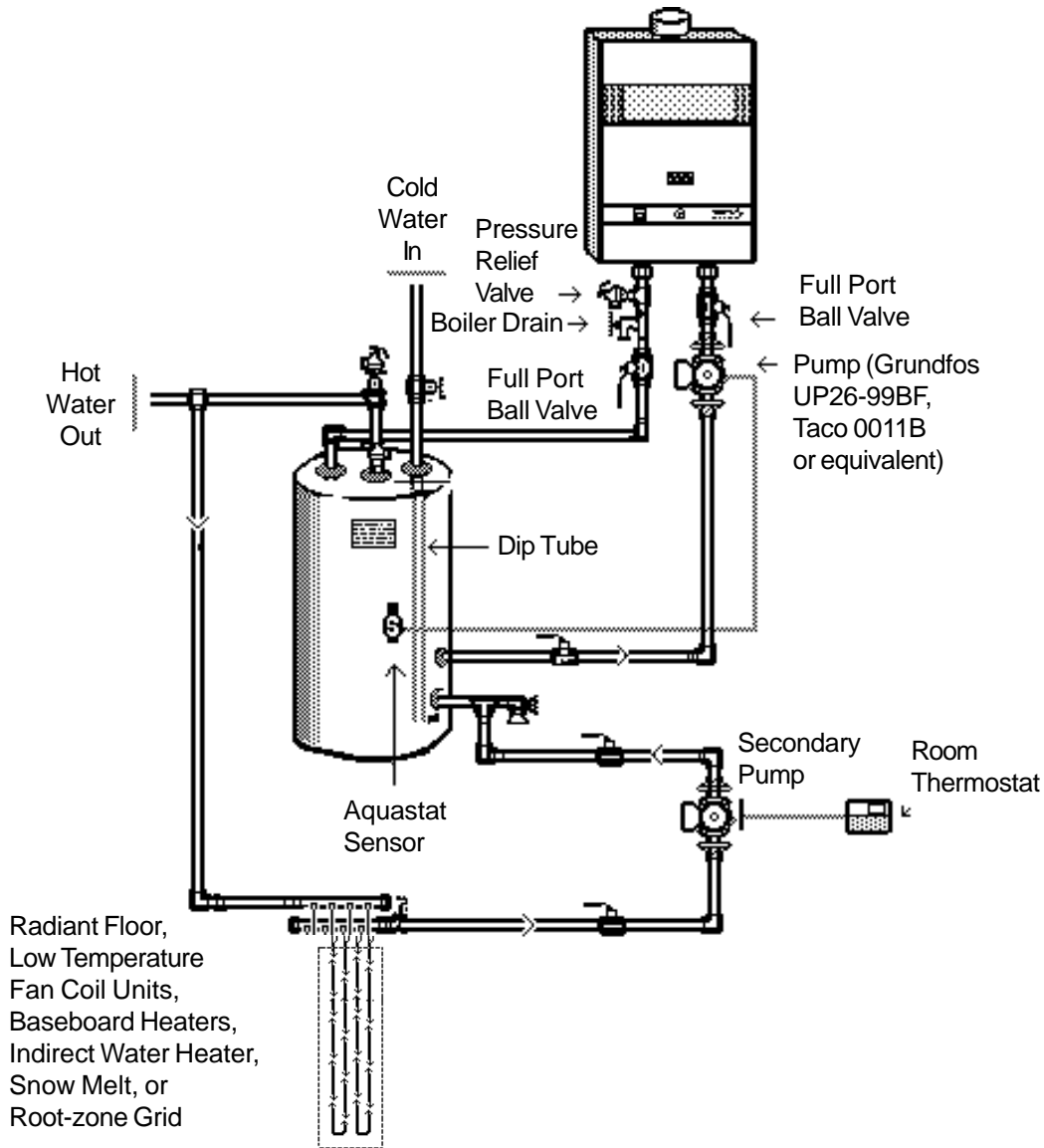

**Fig. 1 Schematic Diagram of Combination Potable Water and Space Heating System**

## RULES FOR SAFE OPERATION

**1.** You should follow these instructions when you install your heater.

In the United States: The installation must conform with local codes or, in the absence of local codes, the National Fuel Gas Code ANSI Z223.1/ NFPA 54.

In Canada: The installation should conform with CGA B149.(1,2) INSTALLATION CODES and/or local installation codes.

**2.** Carefully plan where you install the heater. Correct combustion air supply and flue pipe installation are very important. If a gas appliance is not installed correctly, fatal accidents can result from lack of air, carbon monoxide poisoning or fire.

**3.** The place where you install the heater must have enough ventilation. The National Fire Codes do not allow water heater installation in bathrooms, bedrooms or any occupied rooms normally kept closed. See the section on Pages 7-8 on Locating the Heater.

**4.** You must vent your heater. See section on Vent Pipe Connection, Page 10, paragraph 6 and Venting Guide on page 27.

**5.** The appliance and its individual shutoff valve must be disconnected from the gas supply piping system during any pressure testing of that system at pressures in excess of 1/2 psig (3.5kPa).

The appliance must be isolated from the gas supply piping system by closing its individual manual shutoff valve during any pressure testing of the gas supply piping system at test pressures equal to or less than 1/2 psig (3.5kPa). The appliance and its gas connection must be leak tested before placing the appliance in operation

**6.** Keep water heater area clear and free from combustibles and flammable liquids. Do not locate the heater over any material which might burn, such as carpet.

**7.** Correct gas pressure is critical for the optimum operation of this heater (see specifications on page 3). Gas piping must be sized to provide the required pressure at the maximum output of the heater. Check with your local gas supplier, and see gas line size requirements on page 27.

**8.** As a precaution, shut off your heater if you plan to be away for several days.

**9.** Should overheating occur and the gas supply fail to shut off, turn off the manual gas control valve to the appliance.

**10.** See instructions on setting the water temperature, page 12.

**11.** Do not use this appliance if any part has been under water. Immediately call a qualified service technician to inspect the appliance and to replace any part of the control system and any gas control which has been under water.

**Fig. 2 Parts of AquaStar 80**

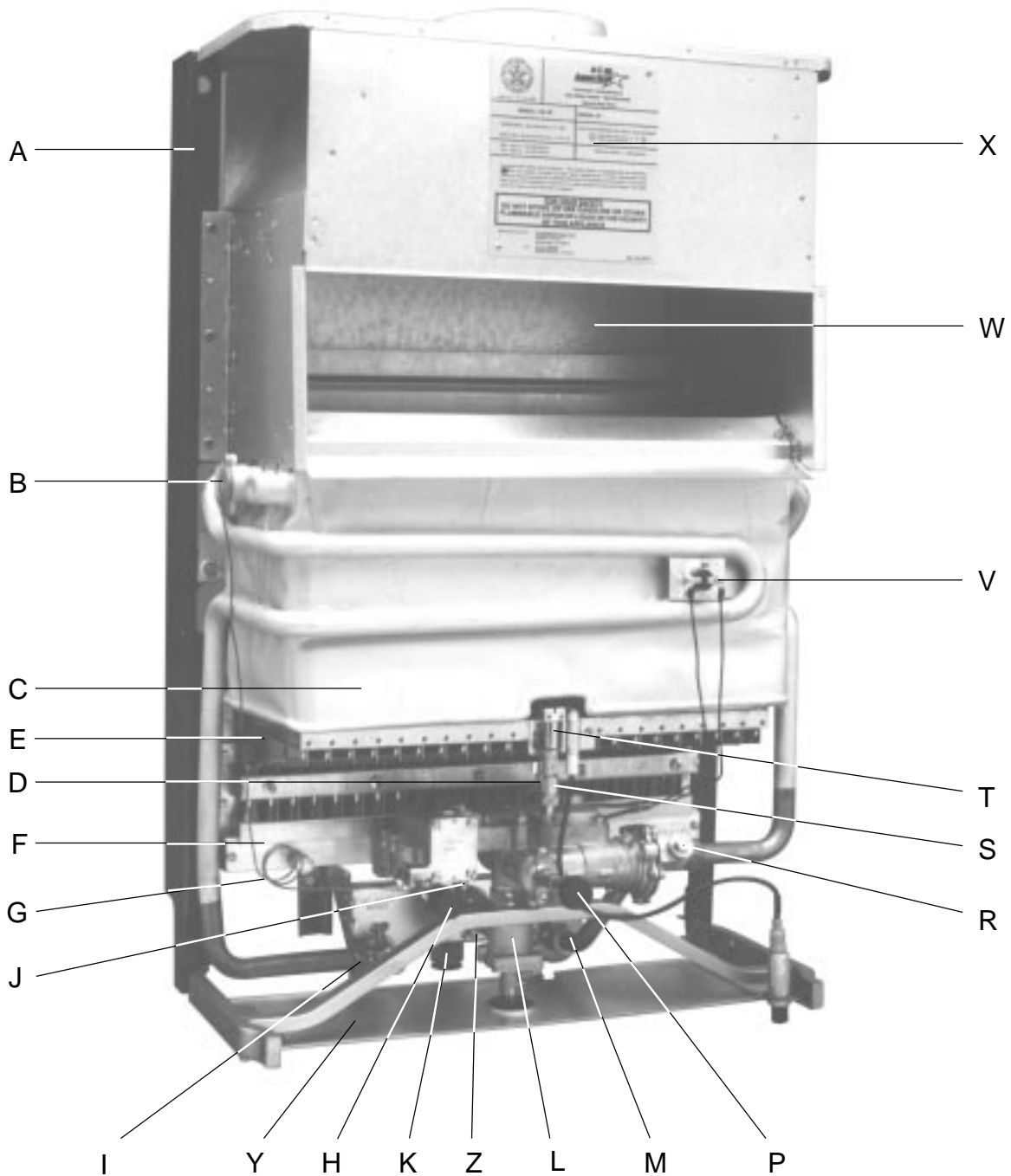

- |                                          |                                       |                                                    |
|------------------------------------------|---------------------------------------|----------------------------------------------------|
| <b>A.</b> hanging frame and back support | <b>I.</b> hot water outlet            | <b>T.</b> pilot                                    |
| <b>B.</b> thermostatic sensor            | <b>J.</b> thermostat adjustment screw | <b>V.</b> overheat shut off sensor                 |
| <b>C.</b> heat exchanger                 | <b>K.</b> gas inlet                   | <b>W.</b> draft hood                               |
| <b>D.</b> thermocouple                   | <b>L.</b> manual gas valve            | <b>X.</b> rating plate-serial # & gas type, etc.   |
| <b>E.</b> burners                        | <b>M.</b> cold water inlet screen     | <b>Y.</b> incandescent particles tray              |
| <b>F.</b> burner manifold                | <b>P.</b> pilot starting button       | <b>Z.</b> gas pressure testing nipple or gas valve |
| <b>G.</b> gas pressure testing nipple    | <b>R.</b> water valve venturi piston  |                                                    |
| <b>H.</b> temperature selector knob      | <b>S.</b> pilot filter                |                                                    |

## LOCATING YOUR HEATER FOR SAFE PROPER COMBUSTION

*Carefully select the location of your new heater. For your safety and for proper heater operation, you must provide an abundant supply of combustion air and install a proper vent. The heater may still operate even when improperly installed. However, an improper installation will be less efficient and may damage the heater. Improper installation can even result in human sickness or death due to oxygen deprivation and carbon monoxide poisoning. Follow the guidelines below:*

**1.** You must not install this appliance in bathrooms, bedrooms, unvented closets or any occupied rooms normally kept closed.

**2.** Simultaneous operation of appliances such as exhaust fans, ventilation systems, clothes dryers, fireplaces or wood stoves may create a vacuum effect in your home. This can cause dangerous combustion by-products to spill back into your home rather than venting to the outside through the flue.

**3.** A simple test for proper ventilation is to introduce smoke (as from a candle) near the louvers on the front of the heater. Have all appliances mentioned in the above paragraph operating at the same time. Have all doors and windows to the outside shut. If the heater does not suck the smoke into the louvers while the heater is operating, you need to supply additional combustion air to the heater and/or improve the vent system.

**4.** Observe the following instructions concerning additional combustion air.

Appliances located in unconfined spaces:

a) An unconfined space is one in which the volume is greater than 50 cubic feet per 1000 Btu per hour of the combined rating of all appliances installed in the space. That would be 6250 cubic feet for the AquaStar 125 alone.

b) In unconfined spaces in buildings of conventional frame, masonry, or metal construction, infiltration is normally adequate to provide air for combustion, ventilation, and dilution of flue gasses.

Appliances located in confined spaces:

The confined space shall be provided with two permanent openings, one commencing within 12 inches of the top and one commencing within 12 inches of the bottom of the enclosure. Each opening shall have a minimum free area of one square inch per:

-1,000 Btu/hr if all air is taken from inside the building.

-2,000 Btu/hr if all air is taken from the outside by horizontal ducts.

-4,000 Btu/hr if all air is taken from the outside by direct openings or vertical ducts.

Louvers, grills and screens have a blocking effect. If the effective free area is not known, assume 20% to 25% for wood louvers and 60% to 75% for metal louvers. Refer to the National Fuel Gas Code for complete information. In buildings of tight construction, all air should be taken from outside.

**5.** Place your heater as close to a vent or chimney as possible. Your hot water lines should be kept short to save energy. It is always best to have hot water lines insulated.

**6.** Having a floor drain or sink nearby is handy in case you need to drain water from your heater.

**7.** Place the heater in a location where water leaks will do NO DAMAGE to adjacent areas or lower floors. CONTROLLED ENERGY CORP IS NOT RESPONSIBLE FOR WATER DAMAGE.

8. For alcove installation, maintain the following minimum clearances from all construction for servicing and proper operations:

	<u>Alcove</u>	<u>Closet</u>
A. Top	6 inches	12 inches
B. Front	OPEN	6 inches
C. Back	0 inches	0 inches
D. Sides	1 inch (Left side 6" for service)	1 inch
E. Floor	6 inches*	12 inches*
F. Flue	6 inches (single wall only)	6 inches

\*Do not install over floor covering which is combustible, such as carpet.

Minimum clearance to combustible materials should not be less than 6" for single wall flue pipe. Note that this can be reduced if combustible materials are protected as per table VI of the National Fuel Gas Code or if Type B gas vent is used. (Follow the minimum clearances for the vent type. We recommend the use of Type B gas vent.

**9. WARNING: THIS WATER HEATER DOES NOT STORE ANY HOT WATER. DO NOT INSTALL IN AN AREA WHERE IT COULD FREEZE. This heater is neither designed for nor approved for outside installation.**

10. The heater must be level before you begin the piping.

## INSTALLATION

*Before installing the unit, be certain your heater is for your type of gas - Propane or Natural Gas. Identification labels for type of gas are found on the shipping box, on the right side panel and on the rating plate which is located in upper part of draft hood seen by removing front panel (See "X" Fig. 2, page 6). Also, each gas orifice is stamped with a number (75 for LPG and 115 for Natural Gas).*

### 1. Hanging the heater on the wall

Place the paper pattern or template (supplied with heater) on the wall where you plan to hang your

heater. Use the adhesive tape which is included in the package to stick the pattern to the wall. Keep in mind that the heater needs to have certain minimum clearances (See paragraph 7 on this page), and that the heater must be level. Drill four holes into the wall at the studs (16 inches on center) as indicated on the template. Use a 1/8 inch drill if screws are to go directly into wood or 1/4 inch if plastic anchors are to be used.

**WARNING: Be sure to remove the paper template before hanging the heater on the wall.**

After the paper template is removed, insert the mounting screws into the two upper holes. Leave 1/2 inch between the wall and the screw head, in order to have enough space for your unit to slip over. The bottom screws will secure the Water and Gas Connecting Strip Assembly to the wall. Next remove the front panel. To do this, remove the temperature selector knob (H) and the pilot starting button by pulling them out. Unscrew the screws under each front corner. Lift the panel up and pull out. At this point, you can either screw the two large screws to fasten the Water and Gas Connecting Strip Assembly to the wall using the pre-drilled holes and connect your pipes directly to the water heater, or you can remove the heater from the Water and Gas Connecting Strip Assembly in order to connect the piping, and then re-connect the heater later. If you decide to connect the pipes directly, skip the next section and go to #3, "Connecting the Gas Line."

### 2. To Disconnect Heater From the Water and Gas Connecting Strip Assembly (Optional)

Refer to figure 3 (following page). Unscrew each brass union nut at the three points marked in figure 3. Be careful not to lose the washers. Remove your heater from the Water and Gas Connecting Strip. Now you can make your water and gas connections as explained in the following sections. When all connections have been made, re-hang the heater on the upper screws and re-connect the brass union nuts making certain that the washers are properly in place.



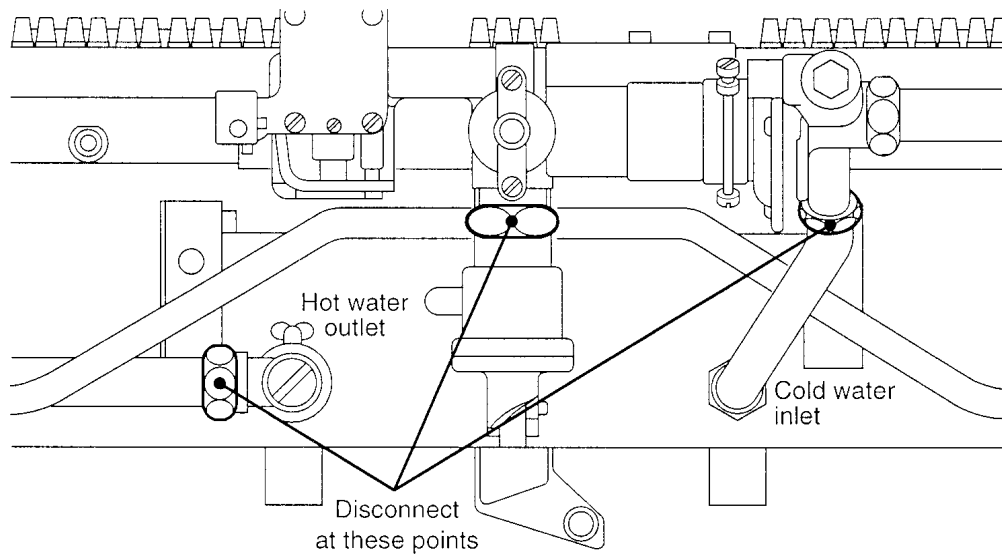

**Fig. 3 To Disconnect Heater From Wall Hanging Strip**

### 3. Connecting the Gas Line

In the United States: The installation must conform with local codes or, in the absence of local codes, the National Fuel Gas Code ANSI Z223.1/NFPA 54.

In Canada: The installation should conform with CGA B149 INSTALLATION CODES and/or local installation codes.

**IMPORTANT** An appliance gas pressure regulator has been supplied with this unit. This regulator must be installed on the gas line within 6 feet of the heater. National Fuel Gas Code requires that a sediment trap be installed on gas appliances not so equipped. The 3/4" NPT gas inlet elbow fitting supplied with the heater connects to the manual gas shutoff valve with a washer gasket. No pipe dope or thread tape should be used at this joint. The 3/4" NPT side of the fitting has a hex shoulder to help you avoid twisting the elbow and requires pipe dope or thread tape to make its seal. The 3/4" size is the minimum for use with Natural Gas and must not be reduced. Propane gas line size requirements are less than those for Natural Gas. Provided the propane gas line is less than 20 feet and serves only the AquaStar, it can be reduced to 5/8". When threading the gas pressure regulator to the gas piping, the indicator arrow on the regulator must be pointed in the direction of gas flow.

**NOTE:** The regulator supplied with the heater is an appliance level regulator designed for low inlet pressure (less than 1/2 LB or 15"W.C.). **DO NOT** connect to an unregulated or high pressure propane line.

When your connections are made, check for gas leaks at all joints (not just ones you made). Apply some soapy water to all gas fittings and gas valve. **Soap bubbles are a sign of a leak.**

**NOTE:** Do not apply soap solution to pilot filter screen or pilot orifice area. If you have a leak, shut off the gas. After verifying that required gaskets are in place, tighten appropriate fittings to stop leak. Turn the gas on and check again with a soapy solution. Never test for gas leaks using a match or flame.

### 4. Connecting the water lines

Although water piping throughout your structure may be other than copper, copper piping should be used for at least three feet before and after the heater (follow local codes if more stringent). Keep water inlet pipe to at least 1/2 inch diameter to allow the full flow capacity. Remember that piping and water pressure must allow sufficient flow to activate the heater when drawing hot water from the top floor. If the hot and cold connections are reversed, the heater will not function.

Sweat your cold water pipe to the AquaStar inlet elbow fitting. **NOTE: The inlet filter screen and water flow restrictor can be damaged by heat if the cold water inlet elbow is attached to the AquaStar when it is sweated to the cold water inlet pipe.** The inlet and outlet elbow fittings seal by means of a union connection with a washer type gasket at the joint. Although these fittings have 1/2" threads, NPT fittings should not be substituted for these elbows and no pipe dope or thread tape is to be used at the joints. Be certain there are no loose particles or dirt in the piping. Blow out or flush out the lines before connecting to the AquaStar.

### 5. Connecting the pressure relief valve

A temperature and pressure relief valve must be installed on the hot water line, close to the heater. No valve is to be placed between the relief valve and the heater. Installation shall be made in such a manner that the discharge from the temperature and pressure relief valve will be conducted to a suitable place for disposal when relief occurs. No reducing coupling or other restriction may be installed in the discharge line. The discharge line must be installed such that it allows complete drainage of both the valve and the line. The location of the relief valve must be readily accessible for servicing or replacement. To accommodate the pressure relief valve, a suitable fitting connected to an extension of a "T" fitting can be sweated to the line. Make the T-fitting extension long enough to ensure that the temperature probe does not interfere with the water flow. The relief pressure of the valve must not exceed 150 psig. The relief temperature of the valve must not exceed 210°F and the discharge capacity must be at least 125,000 Btu per hour.

### 6. Vent pipe connection. **WARNING: Do not reduce the vent pipe size.**

This appliance must be vented to the outside following all local ordinances and specifications for installing a gas appliance vent or chimney. The

venting system must be constructed so as to develop a positive flow adequate to remove flue gasses to the outdoors under all operating conditions.

The appliance must be located as close as practicable to a chimney or vent. The vent pipe sections must be fastened with sheet metal screws. Keep in mind the minimum clearance from the top of your heater. Remember also that single wall vent pipe connectors require a 6 inch clearance from combustibles. National Fuel Gas Code specifies double wall - Type "B" - vent pipe be used in cold climates and for gas vents running through attics. We consider double wall vent pipe preferable in all circumstances. The vent connector should have as much vertical rise as possible (minimum 12") before any horizontal run. Any vent section greater than 45 degrees from vertical is considered horizontal. Horizontal sections of vent connectors must slope upwards at least 1/4 inch for every foot of its horizontal length. Keep the horizontal section short and avoid too many elbows.

**Note:** Although the AquaStar has the same venting requirements as other Category I gas appliances, certain features and specific use characteristics make it more important to have a venting system which exceeds minimum standards. AquaStar thermostats modulate burner output. Therefore, when operating at less than full output, the heater does not have its full heating capacity to warm the flue pipes to create a natural draft. Most gas appliances have longer duty cycles than are typical of instantaneous heaters. For these it is considered sufficient if the appliance can overcome a downdraft within the first five minutes of operation. An instantaneous "on demand" heater like the AquaStar may have frequent operating cycles of less than a minute. If venting and air supply are inadequate to provide a positive draft as soon as the heater turns on, the heater may not remain on long enough to establish a positive draft. See venting guide on page 27.

**FOR YOUR SAFETY READ BEFORE LIGHTING**

**WARNING: If you do not follow these instructions exactly, a fire or explosion may result causing property damage, personal injury or loss of life.**

- A. This appliance has a pilot which must be lighted by hand. When lighting the pilot, follow these instructions exactly.
- B. BEFORE LIGHTING smell all around the appliance area for gas. Be sure to smell next the floor because some gas is heavier than air and will settle on the floor.
 

**WHAT TO DO IF YOU SMELL GAS**

  - Do not try to light any appliance.
  - Do not touch any electrical switch; do not use any phone in your building.
  - Immediately call your gas supplier from a neighbor's phone. Follow the gas suppliers's instructions.
- C. If you cannot reach your gas supplier, call the fire department.
- D. Use only your hand to push in or turn the gas control knob. Never use tools. If the knob will not push in or turn by hand, don't try to repair it, call a qualified service technician. Attempted forceful repair may result in a fire or explosion.
- E. Do not use this appliance if any part has been under water. Immediately call a qualified service technician to inspect the appliance and to replace any part of the control system and any gas control which has been under water.

**LIGHTING INSTRUCTIONS**

1. STOP! Read the safety information above.
2. Push in gas control handle slightly and turn clockwise ↻ to "RED DOT" position.
3. Wait five (5) minutes to clear out any gas. If you smell gas, STOP! Follow "B" in the safety information above. If you don't smell gas, go to next step.
4. Turn handle on gas control counterclockwise ↺ to "RED FLAME" position.
5. Check that manual gas valve handle is on "RED FLAME" position. Push in center PILOT LIGHTING knob on the front of the AquaStar and twist counterclockwise ↺ to 🔱. Push knob all the way in and hold it in. While holding knob in, light the pilot with a match through pilot viewing opening in front of the heater. Check that pilot is lighted. Keep the center knob pressed all the way in for at least 10 seconds after pilot is lighted. Release push knob and turn it clockwise ↻ to 🔱🔱🔱. If pilot goes out, wait 5 minutes before relighting.

In the United States: The installation must conform with local codes or, in the absence of local codes, the National Fuel Gas Code ANSI Z223.1/NFPA 54. In Canada: The installation should conform with CGA B149 INSTALLATION CODES and/or local installation codes. If knob does not pop out when released, stop and immediately call your service technician or gas supplier. If the pilot will not stay lighted after several tries, turn the gas control handle off to "RED DOT" position and call your service technician or gas supplier.

**TO TURN OFF GAS TO APPLIANCE**

Turn gas control shut off handle to the "RED DOT" symbol. Do not force.

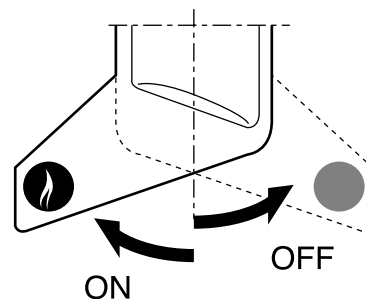

## SETTING THE WATER TEMPERATURE

The AquaStar 80 water heater contains a flow restrictor set at 3 1/4 gpm. Its purpose is to assure that the hot water temperature will always be within a comfortable range regardless of how high one may turn on the hot water faucet or how many faucets may be turned on. Your AquaStar model 80 also has an automatic thermostatic control with a manual temperature setting (Fig. 2 letter H p. 6). For energy efficient operation, we recommend operating this heater at the lowest temperature which you require in your application. This will provide a more consistent temperature over a wider range of flow. Lower temperature settings help prevent temperature fluctuations that may occur when other water outlets are used simultaneously or overall water pressure changes or excessive cold water has to be added. In hard water areas, reducing the water temperature greatly reduces the potential for mineral scale build-up in the heat exchanger.

### What is the best temperature setting?

*Because AquaStar water heaters can deliver endless hot water at the exact temperature which you have selected, there is no need to set it for very hot water and then mix in cold. It just doesn't make sense to overheat water then mix in a lot*

*of cold water to cool it off. Remember you cannot run out of hot water with an AquaStar, so set the dial for the (exact) temperature that you need.*

*Note: 105°F is the maximum recommended for a hot bath. The temperature you select will hold over a range of water flow rates. (See chart, Fig. 6, page 18). You may further vary the temperature by significantly changing the flow rate, particularly at the highest temperature settings.*

Position "5" on the temperature dial is the preferred starting point for setting the temperature control. This setting provides approximately 130°F depending on the flow rate.

Positions "2" and "3" provide approximately 105°F, adequate for a shower depending on flow rate.

Positions "4" through "6" are intermediate settings between warm and very hot.

Position "8" allows for the hottest temperature of about 150°F up to about 1.8 gallons per minute.

**WARNING: 150°F can cause third degree burns.**

<p><b>model "S" version heater.</b> The model "S" is a specifically modified AquaStar which will not overheat if inlet water is already hot.</p>
--------------------------------------------------------------------------------------------------------------------------------------------------

## MAINTENANCE AND SERVICE

Approximately once a year, the AquaStar should be checked, cleaned and serviced as necessary. The following operations must be performed by a qualified service person:

**Vent System:** Should be checked annually. Clean and repair as needed.

**Water Valve (Part #34343):** The water valve on this heater should be serviced periodically depending on hardness of water and conditions of use or whenever signs of corrosion appear at the gas and water valve joint. Servicing the water valve consists of replacing the Push Rod Assembly (part #21107), the Diaphragm (part# 32570), and the Water Valve Spring Loaded Piston (part #34542).

**Drainage:** Drain the heater if there is any danger of freezing. Shut off the water supply, open all hot water faucets, and disconnect the lowest AquaStar fittings and the connections to the water valve (Fig 2, (R), page 6). Loosen the 2 retaining screws at the connection to the gas valve and rotate the water valve 360° to empty all the water. The pressure-temperature relief valve operation should be checked. Perform a manual operation of this valve at least once a year ensuring that a drain is nearby to receive any discharge (see section 5, page 10). Take precautions to avoid contact with hot water coming out of discharge opening and to prevent water damage. **Do not plug the relief valve.** If the relief

valve discharges by itself, a problem exists and service is required. This could be due to a defective relief valve or to overheating.

**Pilot Flame:** The pilot flame should burn with a clean sharp blue flame and should resemble Fig.4 below. If the flame is yellow, or if the central button Fig. 2 (P) has to remain depressed for a long time in order to keep the pilot lighted, the pilot may need to be cleaned or the orifice replaced.

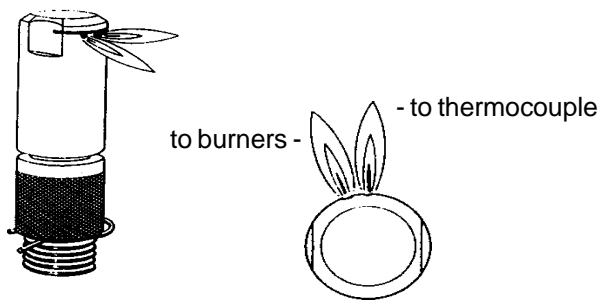

**Fig. 4 Characteristic Pilot Flame**

**To clean the pilot:** Turn off the gas at the unit Fig. 2 (L). Remove the front panel (unscrew screws at bottom of corners of front panel, pull out and lift panel off). Disconnect the Pilot Tube Fig. 2 (S) at its base and blow gently through it (see diagram of Pilot Assembly, page 19). **Be careful not to lose the pilot orifice and washers.** Remove and clean pilot filter by peeling off the outer layer. Do not use any wire or sharp object to clean orifices. Natural gas orifices are large enough that you can usually clean them by blowing through them. LP orifices are too small to clean and should be replaced. **Do not enlarge the orifice.**

**Main Burner Flames:** The main burner flames should be blue, with a more intense blue cone in the center core. Compare with Fig 5 in opposite column. Yellow flames could be a sign of wrong size gas orifices or dirty burners. If some burners have yellow flames while others have good flames, it is likely that dust, lint or spider webs have partially clogged the burner venturi.

Wash the stainless steel burners if they are dirty. Burners can be detached from the heater by removing the pilot tube and the thermocouple assembly and disconnecting the Energy-Cut-Off. **(Do not lose the retaining clip)** The burners are secured to the main frame by two screws on either side. Do not remove the five screws across the front of the burner assembly. Also examine heat exchanger fins for dirt. Brush and vacuum if dirty. Burnt edges at the bottom of the heat exchanger shroud are a sign of inadequate air supply, poor venting or some other combustion problem. The cause of this situation must be corrected: contact your installer, service agency or the gas supplier.

**WARNING: Accumulation of dust and lint on the heat exchanger fins will reduce air flow and could cause corrosion of the copper heat exchanger.** Keep the appliance area clean and free from combustible materials, gasoline and other flammable liquids and vapors. Do not obstruct the flow of combustion air and ventilation air. If installed near a dryer, make sure the dryer is properly vented, and that the AquaStar vents properly when the dryer is operating.

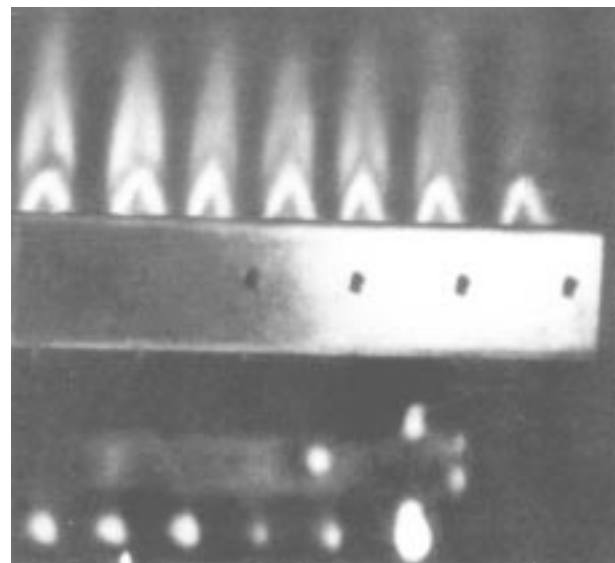

**Fig 5. Characteristic Burner Flame Pattern**

**Mineral Scale Buildup:** AquaStars, when operated at high temperatures or in hard water areas, may need periodic descaling. To check the inside of the heat exchanger for scaling, remove the heat exchanger by first removing the thermostat sensing element (B), page 6. If you note mineral buildup, flush with a descaling solution. Consult your dealer or call CEC for instructions.

---

## TROUBLE SHOOTING

Letter references, e.g. "L" in this section refer to Fig. 2 on page 6.

**Introduction:** The AquaStar burners are ignited by a water flow valve. Numerous water related problems can cause this water valve to malfunction such as:

1. insufficient water flow volume to activate the burners at their minimum flow requirement
2. dirt in the water flow valve causing the valve to malfunction
3. sediment buildup in faucet aerators or shower heads
4. uneven pressures between cold and hot (with single lever faucets)
5. plumbing cross-overs

These water related problems can cause the heater to deliver less than its full output, or to shut down completely.

### SPECIFIC PROBLEMS AND ANSWERS

**Note:** Problems are stated in upper case, bold face. Most common causes for the problems follow in order of likelihood of occurrence. For most of the suggested solutions, it will be necessary to take the front cover of the heater off. To do this, pull the knobs off and remove the screws at front bottom corners, then lift and pull the front panel off. It is also advisable to remove the bottom tray: pull off the plastic handle of the manual gas valve and loosen the side panel bottom screws and then pull the tray down.

### PILOT WILL NOT LIGHT

#### 1. No gas to the AquaStar

- A. Gas cock on gas line may not be open.
- B. AquaStar manual shut off valve at base of heater is not open. Turn handle to red flame symbol.

#### 2. In-line AquaStar gas regulator jammed (usually with LP gas)

Replace or unjam the regulator. **Note:** The regulator furnished with the heater is designed for low gas pressure. Excessive pressure will lock it up. This problem usually happens if the gas pressure between the gas tank and the water heater has not been reduced. See page 3 of your manual for specified gas pressures.

To unjam a regulator, remove the nickel size screw plug on the front. Inside you will see another large screw. Draw a line down the threads to mark the location of the screw. Remove the screw and push on the bottom of the hole with the eraser side of a pencil or similar object. This will release the diaphragm. Reinsert the screw and screw it down to the end of the mark you made.

#### 3. Pilot orifice clogged and/or air screen dirty, or pilot filter is dirty.

Clean the pilot orifice and/or pilot filter screen. Disconnect the pilot tube (T) by unscrewing it. Be careful not to misplace the small washers. The diagram on page 19 shows how the parts of the pilot assembly fit together.

Natural gas orifices are large enough that you can usually clean them by blowing through them. The LP orifice is so small that it is best to replace it. **Never try to enlarge the hole, or use a sharp hard object for cleaning.**

The pilot gas filter is made from a layered material. If it becomes too dirty, a portion of the filter can be separated and peeled off. The clean portion should be loosely reinserted into the pilot burner brass filter chamber. Be careful when re-installing the pilot burner to aim the burner so that the smaller right hand pilot flame touches the thermocouple tip.

#### **4. Pilot orifice may not be correct for your type of gas.**

Pilot orifice is stamped: #18 for LP and #35 for NG.

#### **5. Air in the Gas Line**

**Note:** Normally this is a problem only at the time of installation if the pipes have been worked on, a propane tank has been allowed to empty, or the heater has been shut down for a long time. Bleed all the air trapped in the gas line. Because of the very small pilot orifice (especially on LP gas models), bleeding out all the air could take several minutes. Hold the pilot push button pushed in until all the air has escaped, and the gas has arrived.

### **PILOT LIGHTS BUT FLAME GOES OUT WHEN BUTTON IS RELEASED**

#### **1. Pilot push button was not pushed in far enough or was not held in long enough**

Push pilot button in, turn it to the left, then push it in all the way. Hold it pushed in for at least 20 seconds to give time for the pilot flame to properly heat the tip of the thermocouple before releasing it. *See Lighting Instructions, Page 11.*

#### **2. Pilot flame improperly aimed or is too weak so it is not properly heating the tip of the thermocouple**

The pilot flame has two flames, one aimed at the thermocouple and the other aimed at an angle towards the burners (*see pilot flame diagram, Fig. 4, page 13*). It is extremely important that the flame directed on the thermocouple head be aimed right at it, and that the pilot flame be a sharp blue flame. If the pilot assembly has been taken apart for cleaning, the pilot flame may no longer be properly aimed.

#### **3. Poor circuit connections at the ECO (Energy Cut-Off)**

Oxidation or looseness of the ECO screw connections can result in millivolt current loss through the thermocouple safety circuit. Clean terminals with very fine sand paper or an eraser and retighten terminal screws. (See letter V in Fig 2, page 6).

#### **4. Faulty Energy Cut Off (ECO)- Part 34209**

If cleaning and retightening the screws on the thermocouple wires attached to the ECO did not fix the problem, test the ECO by disconnecting a wire from one side of it and reconnecting it to the other side so both wires are making good contact. Relight the pilot. If the pilot flame now remains on, replace the ECO. If the flame still goes out when the button is released, the ECO is not defective. Go to the next step (#5 below).

#### **5. Poor thermocouple connection at the electromagnet (part #20883)**

**Note:** The electromagnet is located directly behind the pilot push button assembly at the rear of the gas control. Tighten the thermocouple connection to the electromagnet. The connection is a large brass collar and a nut at the back of the gas valve directly opposite the pilot push button assembly. The thermocouple end is a 12 mm (15/32") nut which screws into a 16 mm (5/8") hex fitting on a brass collar. This large brass collar must be snug before you tighten the smaller nut in order to avoid twisting and damaging the thin copper thermocouple tube. Tighten the thermocouple nut snug but not too tight.

#### **6. Faulty thermocouple or electromagnet (parts #20887 and 20883).**

**Unless these parts are at least 8-10 years old, it is very unlikely that they are faulty. Before testing, reconfirm that #2 is absolutely correct, and all connections are clean and tight.** To test the thermocouple, disconnect the thermocouple from the electromagnet and disconnect the thermocouple wires from the ECO.

Attach a multimeter lead on the thermocouple copper tubing below the head, and attach the other meter lead on the ends of both the wires. Light the pilot and take a reading on the meter. If it reads less than 24 mv, replace the thermocouple. If the reading is 24 mv or over, the thermocouple is good.

To test the electromagnet, reconnect the thermocouple and take another reading. The reading should drop to about 14 mv. If it does not, replace the electromagnet.

### **MAIN BURNERS DO NOT IGNITE WHEN HOT WATER IS TURNED ON**

#### **1. Pilot is not on.**

Light the pilot. See lighting instructions.

#### **2. Pilot lighting push button not turned to proper position**

When the pilot flame is on, be sure that the push button is released fully and is turned to the right on the burner position (3 flames symbol).

#### **3. Cold incoming water connection made to wrong side of heater**

Make sure cold water inlet connection is on the right side of heater when you are facing the heater.

#### **4. Water flow rate at hot water tap is too low.**

**Note:** The AquaStar model 80 requires 3/4 gallons per minute flow to activate the burners. This is a flow which fills a quart jar in 20 seconds.

#### **5. Cold water inlet screen on heater is dirty.**

Remove this screen (M in Figure 2, page 6) and clean it.

#### **6. Crossover in household plumbing**

The AquaStar burner activates when there is sufficient water pressure drop in the AquaStar water valve assembly when a hot water faucet is opened. If there is a plumbing crossover, the necessary pressure drop in the AquaStar will not occur. A plumbing crossover can be caused by

a bad washer at a single lever faucet, incorrect piping or an automatic mixing valve in the line which permits hot and cold water to mix in the plumbing. The crossover will create a back pressure in the system preventing the pressure drop in the AquaStar - i.e. cold water is entering the water valve from both sides and the burners will not come on. To confirm there is no crossover in the plumbing, shut off the cold water supply to the AquaStar. Open your hot water taps. There should not be any water flowing. If there is water flowing, there is a crossover in the plumbing. This is a plumbing problem, not an AquaStar problem. Please contact your plumber.

#### **7. Water valve parts may be dirty or components damaged.**

**Note: If #4 is OK, skip this.**

Water valve and component parts must be totally free of dirt. In hard water areas, mineral deposits can eventually (3-5 years) corrode water valve parts to a point where they will need replacing. *Note: there is a small bleed hole under the gas valve at the seam where it is connected to the water valve assembly. Any sign of corrosion at this location is a sign that the water valve assembly components need to be replaced immediately.* Water valve for Model 125 (34343) consists of parts #21107, 32570 and 34542. Contact service person to service the water valve.

### **PILOT LIGHTS BUT GOES OUT DURING OR IMMEDIATELY AFTER HOT WATER USE**

#### **1. Thermostat calibration is incorrect**

The thermostat is not maintaining the proper burner output for the water flow and the heat exchanger is overheating. When this happens, the ECO safety trips and shuts off the main gas supply. After the heat exchanger cools, the ECO resets and the pilot can be relighted. In order to check the calibration, see page 20. If the thermostat cannot be calibrated properly, it is defective and must be replaced (see page 21).



## 2. Gas pressure too low

Very low gas pressure may be caused by low delivered gas pressure, by a jammed gas regulator or by undersized gas lines. If the gas lines are undersized, there may still be the specified static gas line pressure. However, when the water valve opens, the pressure will drop sharply, causing the pilot flame to go out. Have a gas service person confirm the gas pressure both statically and at maximum Btu input. Specifications for your heater are on page 3.

## 3. Burners are not shutting down immediately when hot water is turned off

If burners don't shut off *immediately* when hot water is turned off, the heater will overheat and the ECO will shut off the gas. Replace all three parts in the water valve assembly (parts #21107, 34542, 32570. (See Letter R, Fig 2, page 6).

## WATER IS TOO HOT

### 1. Temperature setting is too high

Unlike storage tank heaters which need to be set at a higher temperature than is needed in order to stretch the volume of hot water by mixing in cold water, an AquaStar can be set for the exact temperature needed and give endless hot water without need for mixing in cold water. We recommend setting the temperature selector dial on #4 or #5. For more information, see section on Setting Water Temperature, Page 12.

### 2. Inlet water temperature is too high (as with preheated water)

**Note:** Only the Model "S" AquaStar should be used if the inlet water is preheated.

### 3. Thermostat is not functioning properly

(See #1 under PILOT LIGHT GOES OUT DURING OR AFTER HOT WATER USE)

## WATER IS NOT HOT ENOUGH

### 1. Temperature dial is set too low

Change the setting.

## 2. Water flow through the heater is higher than the capacity of the AquaStar to heat it

If the AquaStar flow restrictor has been removed, the flow through the heater might be higher than its capacity to heat it. Reduce the flow to a range within which the heater can maintain temperature. See flow chart on Page 18. AquaStar water heaters have a (removable) flow restrictor to assure that the maximum volume flowing through the heater remains in the range that the heater can heat to a suitable temperature, regardless of how many faucets are being used. This is to ensure that the flow is never higher than what the heater can heat to a suitable temperature. The AquaStar model 80 flow restrictor is set for a maximum of 2.2 gallons per minute. **Note:** In private well installations, the high and low cycling control of your water pump may be set too low or the pressure tank may be water logged.

## 3. BTU input is too low due to insufficient gas pressure

**It is extremely important for a tankless water heater to have the right size gas line to obtain the correct gas pressure.**

See specifications for correct gas pressures on page 3. Unlike storage tank water heaters, the burners of a tankless water heater must be very powerful to heat water instantaneously since they do this only at the time hot water is actually being used. It is *imperative* that the gas pressure requirement be met exactly. Insufficient gas pressure will directly affect the water temperature. Static gas pressure in the line can be measured at the pressure test nipple located on the AquaStar manual shut-off valve (Letter L, Fig 2, Page 6). Manifold pressure may be tested at the manifold pressure test nipple (Letter G).

## 4. BTU input is too low due to insufficient gas supply

Make sure your main gas line is fully opened. If using LP gas, minimum size of the propane tank should be 100 pounds for best results.

**5. Cold water is mixing with the hot water between the AquaStar and the outlet**

Compare water temperature at outlet of AquaStar and at the tap. Check for automatic mixing valve plumbing crossover (see #6 - MAIN BURNERS DO NOT IGNITE WHEN HOT WATER IS ON).

**6. Parts in water flow valve (#34343) are corroded**

The gas valve will not open fully if water valve parts are corroded. Replace all three parts in water valve (#32570, #21107, #34542).

**HOT WATER TEMPERATURE FLUCTUATES**

**1. Temperature setting is too high**

Setting the temperature too high will make it necessary to add a great deal of cold water to make the temperature safe and comfortable for contact with the skin. Adding cold to the hot water flow at the tap reduces the flow of water through the AquaStar causing the thermostat to reduce the Btu input or the water valve to shut off if the flow through the AquaStar falls below 3/4 gallon/minute. We recommend setting the temperature selector dial on #4 or #5. See section on Setting Water Temperature, Page 12.

**2. Unbalanced pressure in water lines**

The added restriction caused by the AquaStar in the hot water system can result in uneven pressures between the cold and the hot. In such cases when mixing cold water at the tap, the lower hot water pressure may be overpowered by a much higher cold water pressure, which may cause the AquaStar burners to shut down. Make sure faucet aerators or shower heads are free of minerals. Check that the flow restrictor and filter of the AquaStar are clean

**3. Cold water is mixing with the hot water between the AquaStar and the outlet**

Compare water temperature at outlet of the AquaStar with the temperature at the tap. If different, check for automatic mixing valve or plumbing crossover (see #6, MAIN BURNERS WILL NOT IGNITE) Where automatic "anti-scald" valves are required by code, lower the temperature setting on the AquaStar as much as possible and balance the pressure between cold and hot water after the AquaStar.

**4. Inlet water pressure is erratic due to inadequate supply water pressure or saturated pressure tank on well system**

Check the inlet water pressure and correct if necessary.

**Fig. 6 Temperature/Flow Chart AquaStar 80**

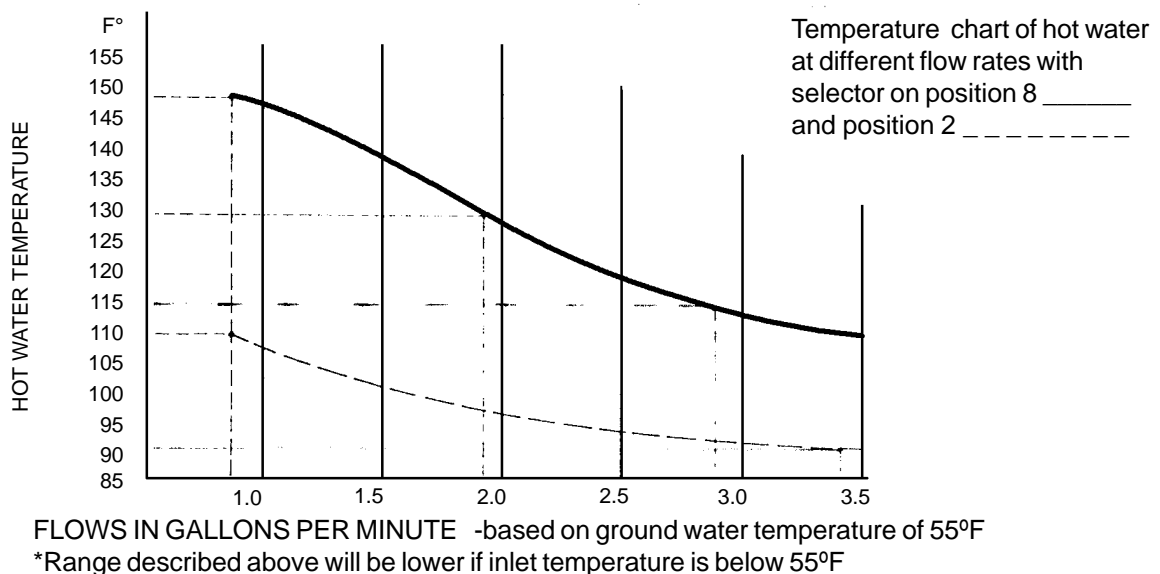

**CLEANING THE PILOT ASSEMBLY**

AquaStar models 80/125/170

**A. Removing Pilot**

1. Hold Gas Pilot Filter Housing in place with one wrench.
2. Unscrew Pilot Tube nut with second wrench.
3. Save the little white Gasket for reassembly.
4. Pivot the tube to the left (loosen base fitting if needed).
5. Remove upper "hairpin" retaining clip.
6. Pull Pilot Assembly downward out of bracket.

**B. Cleaning the Pilot**

1. Separate the chrome Pilot Burner from the brass Gas Pilot Filter Housing. Save the white Gasket for reassembly.
2. Examine the Filter material for dirt. Blowing from the top gets the filter material out of the brass housing. Since the material is layered; dirty layers can be removed. The remaining portion of the filter can be loosely reinserted into the housing. Do not pack the material into the housing as this can obstruct gas flow to the pilot.
3. Check that the Air-Pilot Screen is clean and unobstructed.
4. The pilot injector (orifice) must not be enlarged. The natural gas orifice is large enough that you can visually inspect and clean it. The LP orifice, however, is so small that it is difficult to inspect or clean. We recommend that you change the LP orifice if you

suspect that it might be partially obstructed. If you do not have a replacement orifice, you may blow through it or use a non-residue aerosol cleaning agent (like that used for electronics) can be sprayed through the orifice.

5. Clean any combustion residue from the Pilot Burner tip. Make certain that both holes and the slit are clean.

**C. Reinstalling Pilot Burner to Main Burner Bracket**

1. Insert injector into base of Pilot Burner. Reattach Filter Housing to base of Pilot Burner, making sure to have the Gasket in between.  
 Be certain that the brass Gas Pilot Filter Housing is snug to the Pilot Burner — use two wrenches to tighten.
  2. Pilot holes face in towards Main Burners. Slide Pilot Burner ALL the way up into the bracket.
    - a) Insert Hairpin Retaining Clip to hold Pilot Burner in bracket. Pivot the Pilot Tube back into position below Filter Housing.
    - b) Insert the other Gasket between tube and Filter Housing.
    - c) Use two wrenches to tighten Pilot Tube to Filter Housing.
- 1) One wrench should hold Pilot Burner in right most position, making sure right side flame is aimed precisely on tip of Thermocouple.
- 2) Use second wrench to tighten Pilot Tube nut — **DO NOT OVER-TIGHTEN**

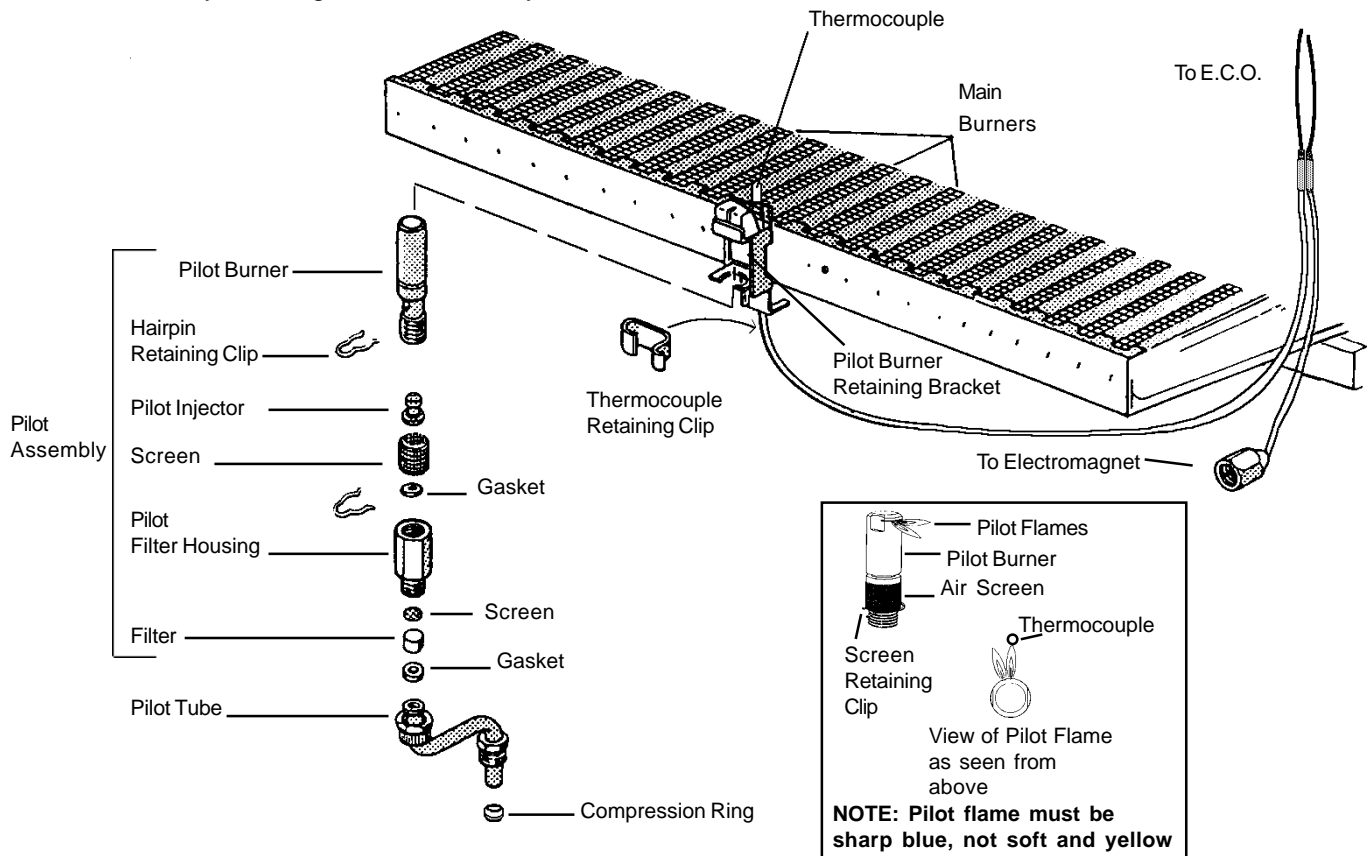

## CALIBRATION AND THERMOSTAT TEST

### SYMPTOMS OF A DEFECTIVE OR IMPROPERLY CALIBRATED THERMOSTAT:

The hot water is too hot. Usually this results in the heater shutting down on overheat safety. The pilot frequently goes out and needs to be relighted.

### PROCEDURE TO CALIBRATE THERMOSTAT

(See diagram for correct location of screw to recalibrate)

1. Turn calibration screw in clockwise all the way, compressing the spring.
2. Back out screw 1 1/2 full turns. When set at the factory, the space from top to bottom portion of the spring should be approximately 5/32" or 4mm.

**NOTE:** Turning the screw in (up) reduces the burner flames. Unscrewing it increases the flames. If a thermostat is in good condition, and the calibration screw is properly adjusted, the water temperature should be 145° (± 5) when temperature dial setting is set at #8 and water is flowing at the minimum burner activating flow of 3/4 of a gallon a minute (Model 125/80) or 1.1 gpm (Model 170).

**NOTE:** Sometimes as a thermostat gets old (5 yrs or so), the space on the screw adjustment may be too loose. In that case, turn the screw in another half or full turn more if need be. It is important that you do not back this screw out so far that the burner flames do not modulate and burners are always on full. Without modulation, the heater will overheat and shut down.

### TEST PROCEDURE TO CONFIRM THERMOSTAT IS WORKING PROPERLY

1. Turn AquaStar temperature setting to #8. This is all the way to the right, clockwise.
2. Turn on a hot water tap at the flow which will turn the AquaStar burners on. If the heater is working correctly, this minimum activation flow will be 3/4 of a gallon a minute, for Model 125/80 and 1.1 for Model 170. This is a flow that can fill up a quart jar in 20 sec. for the Model 125/80 and 15 sec. for the Model 170. If the necessary flow to activate burners needs to be higher than the required minimum, see water valve trouble shooting in your manual. The burners will come on at maximum fire and, within a minute or so the burner flames will stabilize to a lower flame. Water temperature should be around 145°± 5. (This is scalding and too hot to put your hand under.) You should not be able to hold on to the hot water pipe on the left side of the AquaStar.
3. Next turn the temperature dial all the way to the left to the lowest setting #2. Burner flames will become quite small and should remain small. Water temperature, after a minute or so, should stabilize at about 105°± 5. Holding the hot water pipe should be comfortable.
4. Leaving temperature setting at #2, now, increase water flow on higher. You should see the burner flames increase in size, and then decrease when you reduce the water flow.
5. **Note:** If all of the above performs according to this description, the thermostat is working correctly.

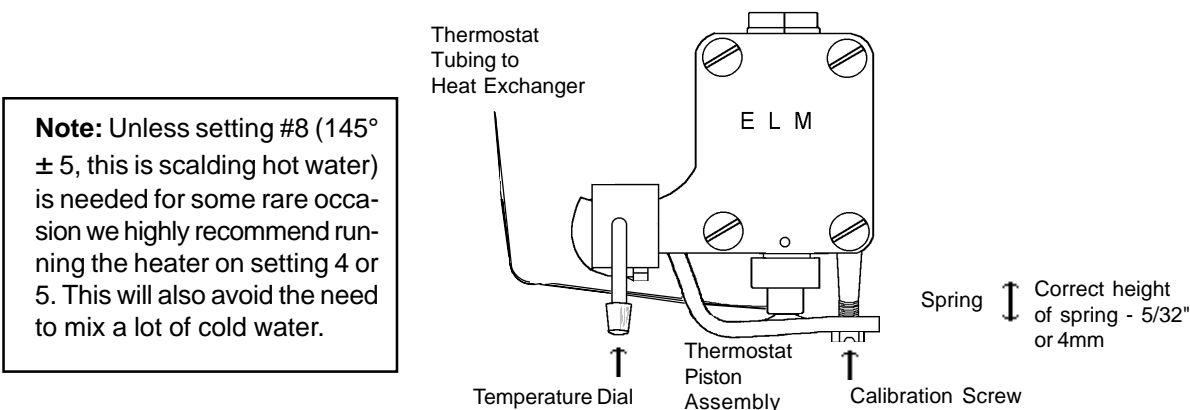

## PROCEDURE FOR REPLACING A THERMOSTAT

### TO REMOVE THERMOSTAT:

**A.** Your replacement thermostat comes as part of a kit. The kit includes additional replacement components to ensure a successful installation. When removing the old thermostat be certain to remove all its components ("O" Ring, and Steel Wedge) prior to installing the replacement thermostat.

1. **Shut off gas to the heater** by turning the handle on the main gas valve.
2. **Shut off the water** supply to the heater and open a faucet on the lowest floor to drain the line and relieve the pressure.
3. Remove the front panel, the left panel, and the bottom tray.
4. Remove the L-Shaped Lever, spring and screw (see fig.A). Screw is covered with a grey cap on newer models. Back out the screw all the way, being careful not to lose the spring, and then remove the L-lever. (Set these three parts aside as a unit, ready to reinstall).

5. Pull down on the thermostat piston assembly to remove it from the gas valve.

**NOTE:** There is a Steel Wedge and an "O" Ring which should come out with the piston assembly. If they do not, reach up with tweezers and/or a magnet for the Steel Wedge and remove them. Be especially careful not to push the Steel Wedge into the valve housing.

6. Remove the two screws at the other end of the thermostat (located on the upper left side of the heat exchanger) and slide the capillary sensor out of the heat exchanger. **Note:** You should have a basin ready to collect the water that will then be released from the heat exchanger.

### TO INSTALL NEW THERMOSTAT:

**B.** When working with the thermostat, be careful not to damage it: The copper capillary tube is hollow and can be damaged if crimped or bent too sharply.

1. Insert the capillary sensor into the heat exchanger. Be sure that the rubber gasket seats properly and then retighten the two screws.

2. Slide the new Brass Collar over the piston.

3. Slide the "O" Ring over the piston so that it seats above the Brass Collar.

4. Place the Steel Wedge into the piston cup. Position it so it is oriented with a flat side facing you. A dab of grease or silicone will help it stay in place.

5. Slide the assembly into the valve housing, ensuring that the Steel Wedge does not shift to an angled position.

6. Reinstall the L-Shaped Lever, spring and screw. Be sure the left side of the L-lever is positioned over the cam. Tighten the screw in all the way so the spring is compressed. Now calibrate the thermostat.

7. To calibrate the thermostat properly, continue with the calibration and thermostat test on the following page.

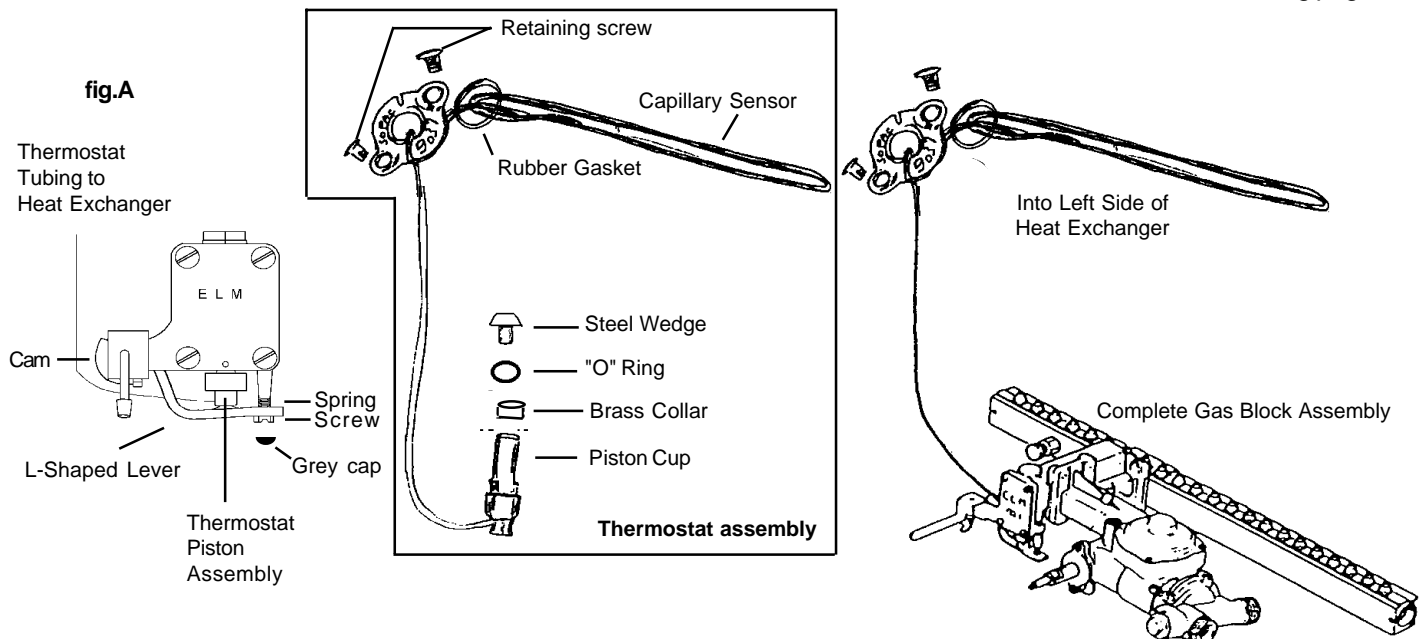

## DESCRIPTION OF OPERATION OF AQUASTAR 80/125 MODELS

### WATER PATH

Cold water entering the Cold Water Inlet passes through a nylon mesh Water Filter Screen (#21) which filters out dirt and debris. Water then passes through the Water Flow Restrictor (#8) which prevents water flow from exceeding 3.25 gallons per minute. The flow control is there to help ensure that water does not flow through the heat exchanger faster than the burners can heat it. The restrictor can be removed if needed.

From the Flow Restrictor the water moves up to #3, the Water Flow Sensor. This entire unit is also known as the Water Valve Assembly. The spring pressure of the Venturi Piston (#23) diverts most of the water flow into the diaphragm chamber. The only way out of the diaphragm chamber is through a smaller hole, the venturi. Water squirting through the venturi creates a pressure buildup on the high pressure side of the diaphragm chamber. The water pressure is lower on the other side of the venturi hole. A small tube transfers this reduced pressure to the low pressure side of the diaphragm chamber.

The pressure differential moves the diaphragm which exerts force on the Push Rod (#25). At 3/4 gallons per minute, the pressure differential becomes sufficient to overcome the spring pressure of the Gas Flow Valve (#7) opening the gas valve.

The water then moves through the Heat Exchanger (#1) where it absorbs approximately 80% of the heat from the burners. The balance of the heat is exhausted with the flue gases. Located midway through the Heat Exchanger, a Water Temperature Probe (#17) senses water temperature. It works with the Gas Flow Valve (#6) to regulate the amount of gas to the burners.

Before the water leaves the Heat Exchanger it passes the Overheat Sensor Switch (#19). This is a safety device which causes other gas controls to shut off all the gas if the Heat Exchanger overheats.

### GAS FLOW PATH

The appliance Gas Regulator (#24) at the inlet to the heater ensures that gas pressure fluctuations don't over-pressure the heater. The Manual Gas Flow Shut-off Valve (#14) provides a quick gas shut off right on the heater.

The gas shut-off safety devices are integrated with the pilot light. An Electro-Magnet in the Gas Valve ensures that gas flows to the burner only when there is a pilot light to ignite it. The Pilot Knob (#15) shuts gas off to the burners while you light the pilot. You must hold the Pilot Knob in at the single flame position long enough for it to heat the Thermocouple (#12).

The water activated gas valve (#7) opens and shuts in response to water flow. On heaters fueled with LP Gas, a Slow Ignition Device (#4) gradually increases gas flow for ignition. The Natural Gas models have no such device because Natural Gas is delivered at a much lower

The Thermocouple (#12) produces a very small amount of electricity (0.03 volts) when it is exposed to a flame. This electricity is just enough to hold open the spring-loaded Electromagnet Gas Flow Shut-off Valve (#13). If the thermocouple is not hot enough, the spring closes the valve. Pushing #15 in the single flame position, allows gas to flow to the pilot. Gas can't go to the burners until the pilot has been lighted and the knob has been turned to the three flame position and released.

If a malfunction causes the Heat Exchanger to get too hot, the Overheat Sensor Switch (#19) interrupts the electrical circuit between the thermocouple and electromagnet. This safety feature shuts off the gas to both burners and the pilot. Manual relighting is required once the problem is corrected.

The Thermostatic Gas Flow Modulator (#5) works with the Water Temperature Probe (#17) to modulate the amount of gas delivered by the thermostatically controlled Gas Flow Valve, (#6). Initially the water in the Heat Exchanger is cold, the Gas Flow Valve allows a full flow of gas to the Burners (#2). Then depending on the flow rate, inlet water temperature and/or the Thermostatic Temperature Selector (#20), the Gas Flow Valve (#6) adjusts gas flow anywhere from 25,000 /125,000 Btu's (Model 125) and 25,000/77,500 (Model 80).

Special "S" version heaters have the ability to further modulate gas flow so that the effective output approaches 0. This permits the AquaStar 80/125 vpS to work effectively and safely with pre-heated water.



**HOUSING COMPONENTS DIAGRAM**  
**AQUASTAR 80**

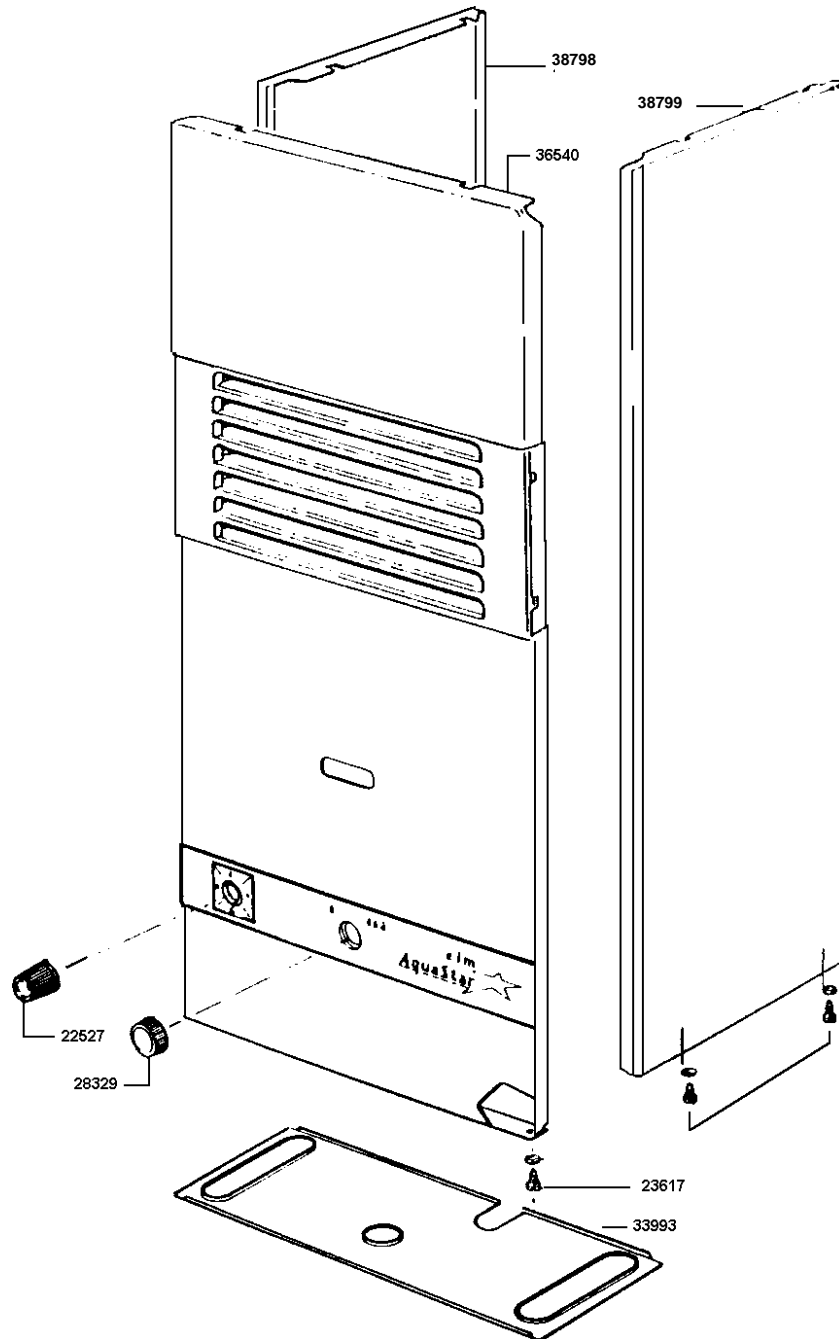

**SPARE PARTS LIST**

38798 - RIGHT SIDE PANEL  
 38799 - LEFT SIDE PANEL  
 22527 - TEMPERATURE  
 SELECTOR KNOB

23617 - PANEL RETAINING  
 SCREW  
 28329 - PILOT STARTER KNOB

36540 - FRONT PANEL  
 33993 - INCANDESCENT  
 PARTICLE TRAY



**INTERIOR COMPONENTS DIAGRAM  
 AQUASTAR 80**

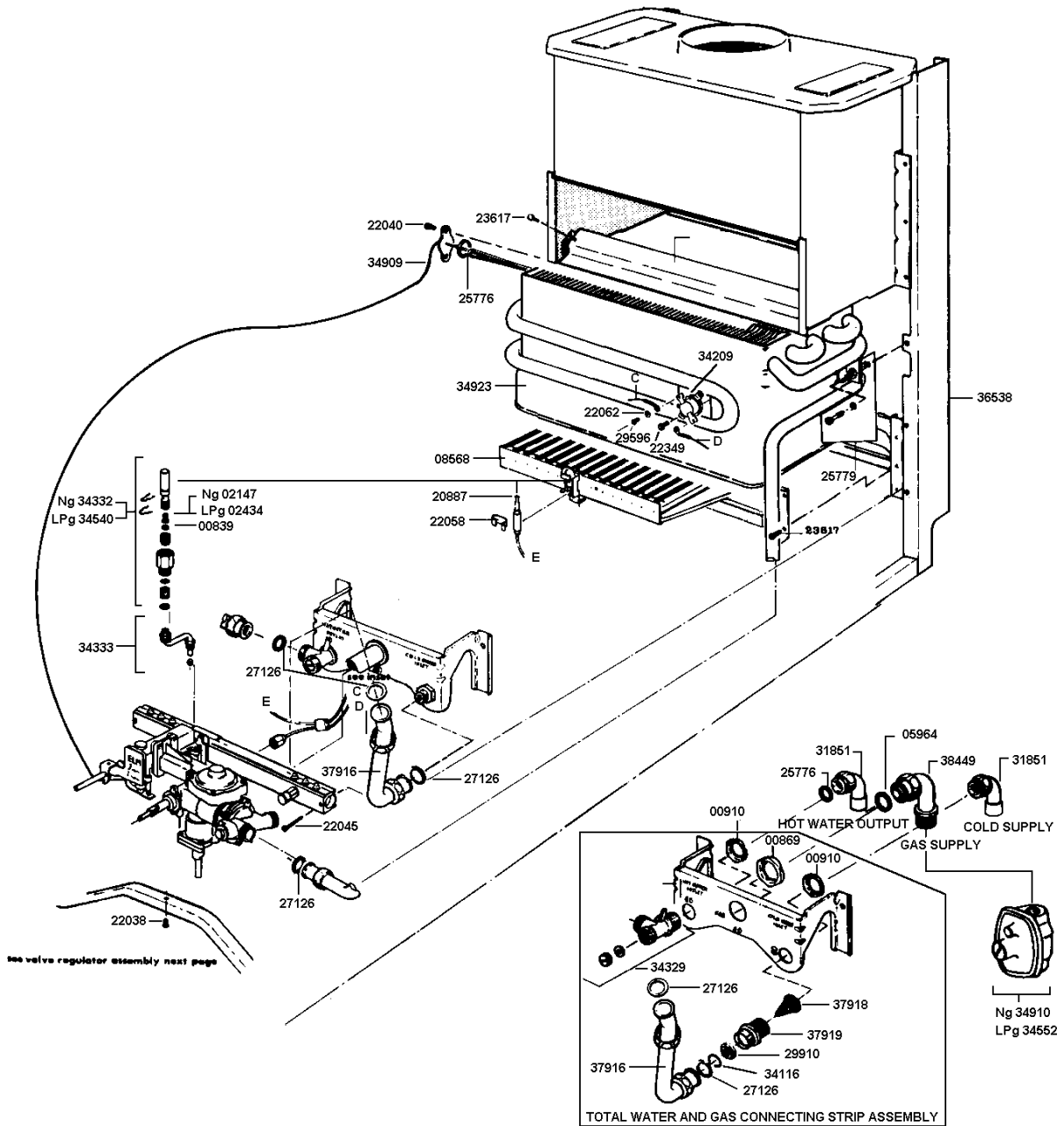

**SPARE PARTS LIST**

- |                                                           |                                                                         |                                                            |
|-----------------------------------------------------------|-------------------------------------------------------------------------|------------------------------------------------------------|
| 00839 - PILOT WASHER                                      | 23617 - REAR BURNER SHIELD RETAINING SCREW                              | 34316 - FRAME                                              |
| 00869 - RETAINING NUT FOR GAS INLET FITTING               | 25687 - DRAFT HOOD DEFLECTING STRIP                                     | 34329 - HOT WATER RETURN LINE FITTING                      |
| 00910 - RETAINING NUT FOR COLD INLET AND HOT WATER OUTLET | 25776 - WASHER                                                          | 34332 - NG TOTAL PILOT ASSEMBLY                            |
| 02147 - NG GAS PILOT INJECTOR                             | 25779 - HEAT EXCHANGER FRAME RETAINING SCREW                            | 34333 - PILOT TUBE ASSEMBLY ("S" TUBE)                     |
| 02434 - LP GAS PILOT INJECTOR                             | 27126 - WASHER                                                          | 34540 - LP TOTAL PILOT ASSEMBLY                            |
| 05964 - GAS FITTING WASHER                                | 29596 - THERMOCOUPLE / ELECTROMAGNET LEAD WIRE TERMINAL RETAINING SCREW | 34552 - LP GAS REGULATOR                                   |
| 08565 - BURNER ASSEMBLY                                   | 29910 - INLET WATER FLOW RESTRICTOR                                     | 34923 - HEAT EXCHANGER                                     |
| 20887 - THERMOCOUPLE                                      | 31851 - COLD & HOT WATER ELBOW                                          | 37916 - WATER VALVE TO COLD INLET CONNECTING COPPER TUBING |
| 22040 - THERMOSTAT SENSING ELEMENT RETAINING SCREW        | 34116 - CLIP                                                            | 37918 - WATER FILTER                                       |
| 22045 - BURNER MANIFOLD RETAINING SCREW                   | 34209 - OVERHEAT THERMOSTATIC SENSOR (ECO)                              | 37919 - COLD WATER INLET FITTING                           |
| 22058 - THERMOCOUPLE RETAINING CLIP                       | 34296 - WATER & GAS FITTING RETAINING STRIP                             | 38449 - COPPER ELBOW GAS FITTING                           |
| 22062 - WASHER                                            |                                                                         |                                                            |
| 22349 - SCREW                                             |                                                                         |                                                            |

# VALVE ASSEMBLY COMPONENTS DIAGRAM AQUASTAR 80

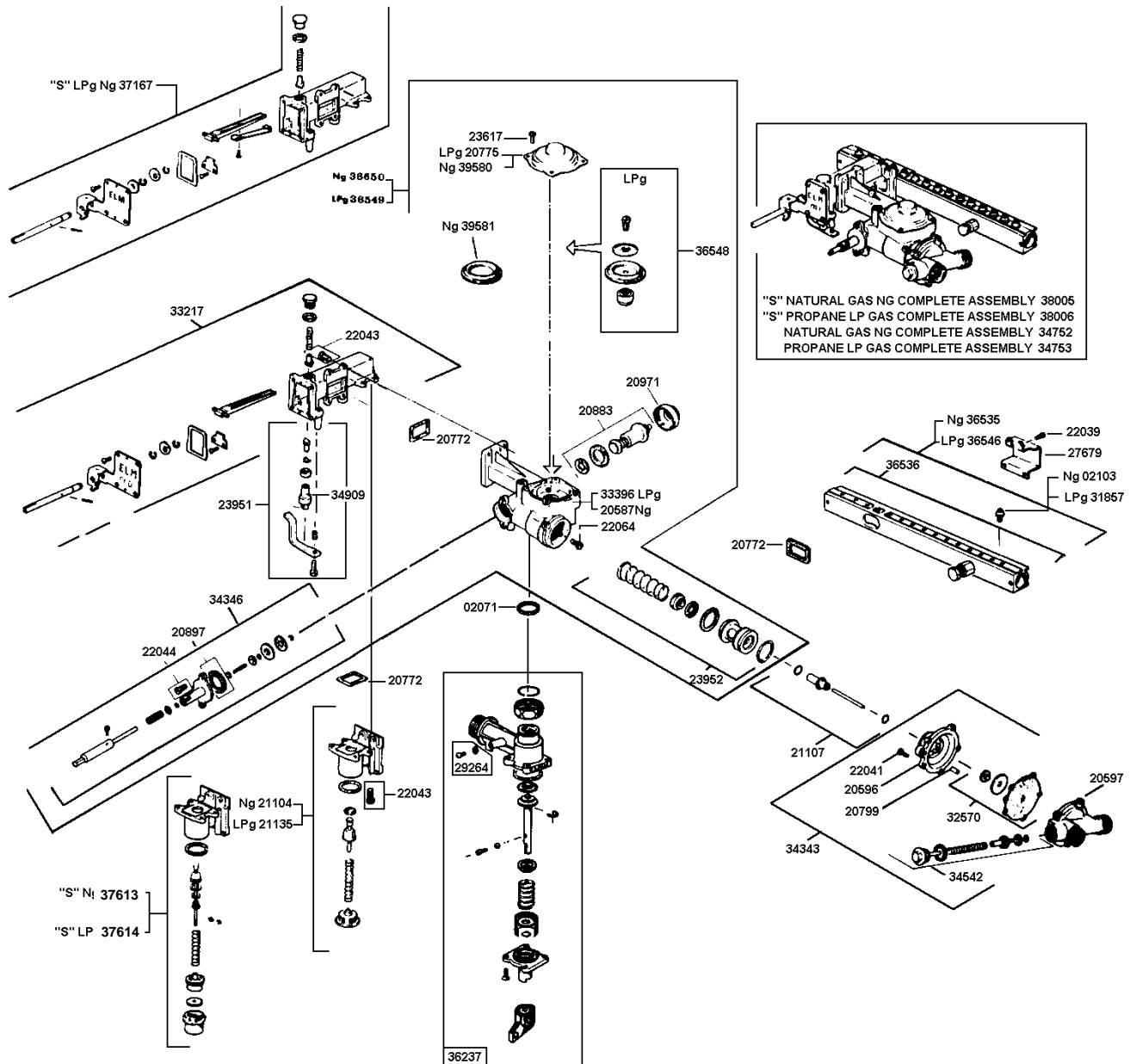

## SPARE PARTS LIST

- |                                                             |                                                        |                                                                           |
|-------------------------------------------------------------|--------------------------------------------------------|---------------------------------------------------------------------------|
| 02071 - MANUAL GAS VALVE GASKET                             | 22039 - SCREW FOR MANIFOLD CLAMP                       | 34752 - NG COMPLETE BLOCK ASSEMBLY                                        |
| 02103 - INJECTORS - NG                                      | 22041 - WATER VALVE RETAINING SCREW                    | 34753 - LP COMPLETE BLOCK ASSEMBLY                                        |
| 20596 - WATER VALVE COVER                                   | 22043 - THERMOCOUPLE PUSH BUTTON COVER RETAINING SCREW | 36103 - GASPRESSURE TEST NIPPLE                                           |
| 20597 - WATER VALVE HOUSING                                 | 22064 - TIGHTENING SCREW FOR WATER VALVE               | 36535 - BURNER MANIFOLD WITH NG INJECTORS                                 |
| 20772 - CORK GASKET                                         | 23617 - REGULATOR COVER SCREW                          | 36536 - GAS MANIFOLD WITHOUT INJECTORS                                    |
| 20775 - REGULATOR COVER                                     | 23951 - THERMOSTAT SETTING COVER ASSEMBLY              | 36546 - BURNER MANIFOLD WITH LP INJECTORS                                 |
| 20799 - CENTERING TUBE                                      | 23952 - GAS VALVE ASSEMBLY                             | 36548 - LP GAS SLOW IGNITION MEMBRANE ASSEMBLY                            |
| 20883 - ELECTROMAGNET WITH WASHER                           | 31857 - LP GAS INJECTORS                               | 36549 - LP MAIN VALVE ASSEMBLY                                            |
| 20897 - THERMOCOUPLE PUSH ROD COVER CORK WASHER             | 32570 - WATER VALVE RUBBER MEMBRANE                    | 36650 - NG MAIN VALVE ASSEMBLY                                            |
| 20971 - ELECTROMAGNET RETAINING COVER                       | 33217 - THERMOSTAT MODULATING VALVE ASSEMBLY           | 37167 - MODEL "S" GAS MAIN VALVE ASSEMBLY                                 |
| 21104 - NG MODULATING THERMOSTATIC VALVE ASSEMBLY CONNECTOR | 34343 - COMPLETE WATER VALVE ASSEMBLY                  | 37613 - MODEL "S" NG MODULATING THERMOSTATIC VALVE ASSEMBLY CONNECTOR     |
| 21107 - WATER VALVE PUSH ROD                                | 34346 - THERMOCOUPLE AND ELECTROMAGNET PUSH BUTTON     | 37614 - MODEL "S" LP GAS MODULATING THERMOSTATIC VALVE ASSEMBLY CONNECTOR |
| 21108 - NG VALVE HOUSING                                    | 34542 - WATER VALVE SPRING LOADED PISTON               | 38005 - MODEL "S" NG GAS BLOCK ASSEMBLY                                   |
| 21135 - LP GAS THERMOSTATIC MODULATING VALVE ASSEMBLY       |                                                        | 38006 - MODEL "S" LP GAS BLOCK ASSEMBLY                                   |
|                                                             |                                                        | 39580 - NG REGULATOR COVER                                                |
|                                                             |                                                        | 39581 - O RING                                                            |

# INSTALLATION CHECKLIST



## Gas Line Size\*

### Natural Gas

Nominal Iron Pipe Size*	1/2"	3/4"	1"	
Model 80	25"	100'	150'	
125	NR	40'	125'	
170	NR	25'	80'	

### Liquid Propane

Semi-rigid Tubing	1/2"	5/8"	3/4"	7/8"
Model 80	15'	50'	100'	
125	NR	20'	50'	100'
170	NR	NR	35'	70'

\*Flex tubing greatly reduces capacity and, therefore, is not recommended.

### Minimum Vent Size\* and Height

Model	Min. Diameter	Min. Height	Alternative
80	4"	10'	6' with 5" vent
125	5"	10'	6' with 6" vent
170	6"	10'	6' with 7" vent

**\*WARNING:** Vent size must not be restricted. Installation must comply with national and local codes.

### Water Pressure

For installation on well systems, insure that your water pressure is between 30 - 50 psi.

# LIMITED WARRANTY

## Residential e.i.m. Aquastar

### GENERAL

Controlled Energy Corporation (CEC) will furnish a replacement heat exchanger and will furnish a replacement of any other part, which fails in normal use and service within the applicable periods specified below, in accordance with the terms of this warranty. The CEC replacement will be warranted for the unexpired portion of the original warranty. This warranty will be valid only for water heaters in the possession of the original consumer purchaser as recorded on the warranty card.

### THE HEAT EXCHANGER

If the Heat Exchanger fails within TEN (10) years after the original installation and operation, CEC will furnish a replacement heat exchanger. However, if the water heater is installed in other than a single family dwelling, or is used as a circulating heater in any application, this heat exchanger warranty is limited to TWO (2) years from date of original installation and operation.

### ALL OTHER PARTS

If any other part fails within TWO (2) years after original installation and operation, CEC will furnish a replacement part free of charge.

### SHIPPING COSTS

In addition to supplying the replacement part (s), CEC will pay transportation costs for these parts to a convenient delivery point near you selected by CEC, such as a local AQUASTAR dealer or distributor.

### SERVICE LABOR COSTS

This warranty does not cover any labor costs associated with service, removal or re-installation of the part (s). All such costs must be borne by you, the purchaser.

### EXCEPTIONS

This warranty will not apply:

- 1) to defects or malfunctions resulting from failure to properly install, operate or maintain the unit in accordance with the printed instructions provided;
- 2) to damage from abuse, accident, neglect, or freezing and other acts of nature;
- 3) to damage resulting from operation with either the thermocouple or overheat sensor removed;
- 4) TO FAILURES OF THE HEAT EXCHANGER RESULTING FROM THE OPERATION OF THE WATER HEATER IN A CORROSIVE ATMOSPHERE OR AT WATER TEMPERATURES EXCEEDING

THE MAXIMUM RATING, OR IF THE WATER HEATER IS NOT SUPPLIED WITH POTABLE WATER.

- 5) to defects or damage caused by any attachment or modification, including any energy saving device.

NOTE: THE WATER HEATER MUST BE FREE OF DAMAGING SCALE DEPOSITS AND NOT SUBJECT TO GAS PRESSURES GREATER THAN THOSE SHOWN ON THE RATING PLATE, WHICH MUST NOT BE ALTERED, DEFACED, OR REMOVED.

### HOW TO MAKE A CLAIM

Any claim for warranty service should be made to your local dealer or distributor, or to CEC. If to CEC, please contact the Service Department:

Controlled Energy Corporation  
Fiddlers' Green  
Waitsfield, Vt., 05673  
Phone 802-496-4436

In most cases, the dealer or distributor will be able to promptly honor your claim and notify CEC subsequently. However, ALL REPLACEMENTS ARE MADE SUBJECT TO VALIDATION BY CEC OF INWARRANTY COVERAGE. The damaged or defective item must be made available in exchange for the replacement.

### MISCELLANEAOUS

No one is authorized to make any other warranties on behalf of CEC. IT IS EXPRESSLY UNDERSTOOD THAT THE REPLACEMENT WARRANTY OF CEC SHALL BE IN LIEU OF ANY AND ALL OTHER WARRANTIES, EXPRESS OR IMPLIED, INCLUDED WARRANTIES OF MERCHANTABILITY OR FITNESS FOR A PARTICULAR USE OR PURPOSE, AND FURTHER THAT CEC SHALL NOT BE LIABLE FOR ANY LOSS OR DAMAGE DIRECTLY OR INDIRECTLY ARISING FROM THE USE OR THE WATER HEATER, OR FOR ANY CONSEQUENTIAL DAMAGES ARISING FROM SUCH USE (INCLUDING DAMAGES FROM WATER LEAKAGE).

CEC's sole liability with respect to any defect shall be for the replacement of the defective part (s). Some states do not allow such limitations and exclusions, so the above may not apply to you.

This warranty gives specific legal rights. You may also have other rights which vary from state to state. Please fill out and mail the enclosed WARRANTY CERTIFICATE within THIRTY (30) days after installation.

In the event warranty service is required, reasonable proof of the effective date of installation and operation must be provided; otherwise, it may not be possible to honor this warranty.

Replacement Parts available from  
NATIONAL DISTRIBUTOR

## CONTROLLED ENERGY CORP.

Fiddler's Green Waitsfield,  
Vermont 05673 (U.S.A.)

Phone (802) 496-4436 / (800) 642-3111  
Fax (802) 496-6924

MANUFACTURER

## e.i.m. leblanc s.a.

123-125, rue Diderot - 93700 DRANCY  
(FRANCE)

Tél. 01.48.30.11.12

Telex : 235 406

Fax : 01.48.30.86.21