

Ecomatic HS 3220

Multifunction Electronic Controller for Hydronic Systems

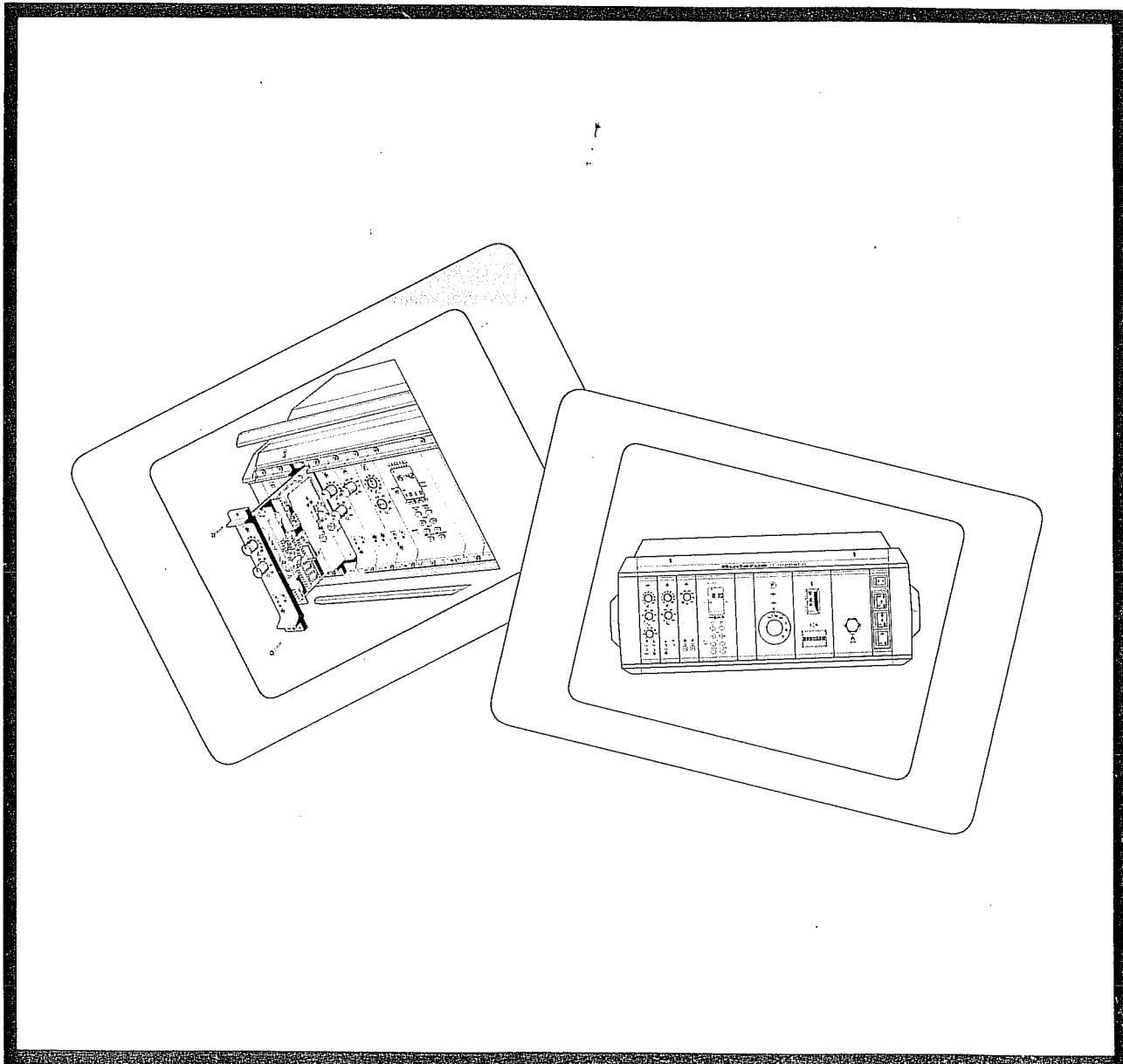

Description:

The Ecomatic HS 3220 is a fully modular 'intelligent' heating system controller that helps achieve maximum efficiencies without resorting to the use of condensing boiler technology. This control offers the full benefits of sophisticated weather-responsive energy management controls designed for commercial equipment and makes these features available to the residential user. With over 1,800,000 Ecomatic controls installed worldwide, both the installer and user can be confident that the performance and durability of the HS 3220 has been well proven in the field.

The internal wiring block of the Ecomatic HS 3220 accepts connections for all sensors, burner, heating and domestic hot water circulators, as well as a hot water recirculation pump.

Power requirements are 110-120 Volts AC 60 Hz. The Ecomatic HS 3220 meets or exceeds UL 873 requirements.

Because the Ecomatic HS 3220 is a modular control that can be delivered in multiple configurations, all modules discussed in this manual may not be present on the control being installed. Additional modules may be easily installed at a future time.

The Ecomatic HS 3220 base configuration is comprised by:

- 1 Boiler Reset module (#004)
- 1 Microcomputer Timer Module (#071)
- 1 Boiler Aquastat/Redundant High Limit Module (#126)
- 1 Boiler Water Temperature Readout Module (#042) *
- 1 High Limit Reset Module (#100) *
- 1 Operations Module (#128) *

Optionally, it may include:

- 1 Mixing Valve Reset module (#005)
- 1 Domestic Hot Water Module (#006)

* Modules with no installer adjustments

To remove or replace a module, remove in order:

- transparent front plastic cover
- upper and lower horizontal cover strips. (Flex slightly in middle to remove.)
- Remove upper and lower phillips-head screws
- Insert Module Puller into screw holes. Pull out module.
- Replace gently, taking care that circuit board is correctly aligned with internal guide rail.

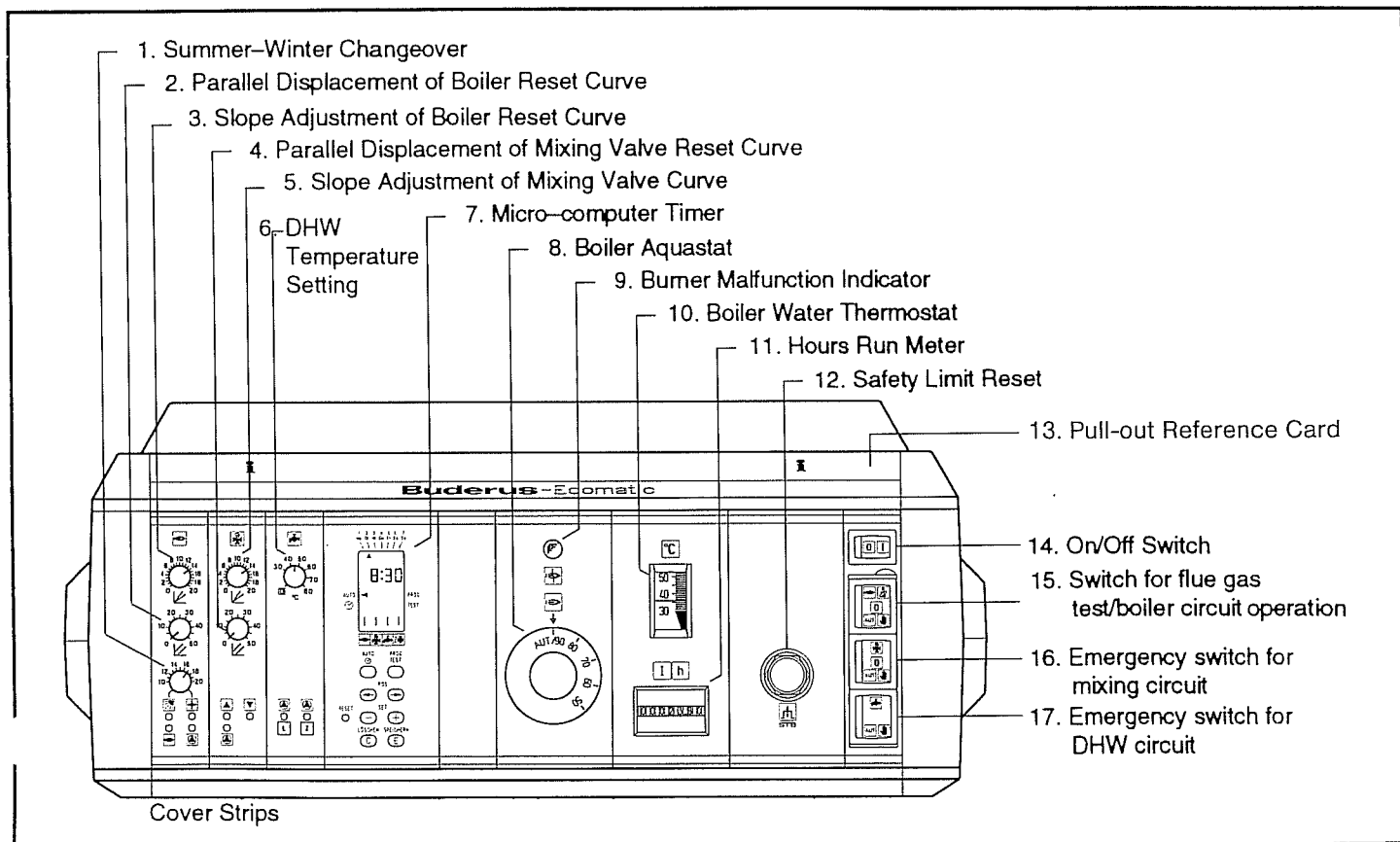

Why an Ecomatic?

The versatility and precise control that microchip technology has brought to so many aspects of modern life are finally available for hydronic heating system control. Fuel use economies of up to 30% become possible when compared to new conventional hot water heating systems using traditional wall thermostat/multi-zone configurations. Occupant comfort is increased to a point never dreamed of before. And at Buderus, we believe that once you, the installer, have familiarized yourself with the features incorporated in the Ecomatic HS 3220 and learn how to use them fully, you will not want to install heating systems any other way.

Specific 'smart' functions of the Ecomatic HS 3220 are:

1) Fully Adjustable Outdoor Reset Control

Because boilers and radiation are sized to local design temperatures which are only reached 2 or 3 days a year, heating equipment necessarily operates in an 'oversized' mode for the bulk of the heating season when temperatures are 20°, 30°, or even 50° higher! Reset control, which lowers the temperature at which the boiler operates and at which water is delivered to the radiation as a function of rising outdoor ambient temperature is fully utilized by the Ecomatic HS 3220. These lower boiler temperatures reduce off-cycle heat losses, and as a result, heating costs.

Furthermore, user comfort increases dramatically when radiation is provided with constant circulation of heating water at lower temperatures. Expansion/contraction noises from piping are eliminated.

The necessary heating water temperature for any given outdoor temperature is called the reset curve. As you can see from the accompanying diagram, there are several different reset curves. Each expresses a relationship between the type of heat distribution system used and the thermal characteristics of the space in which it is located. The angle (or 'slope') of the curve can be calculated by this formula:

$$\text{Slope} = \frac{T_s - T_r}{T_r - T_o} \times 10$$

where

T_s = design supply water temperature

T_r = design room temperature

T_o = design outdoor temperature

Example:

Design supply water temperature = 180°F

Design room temperature = 70°F

Design outdoor temperature = 0° F

$$\text{Slope} = \frac{180 - 70}{70 - (-10)} \times 10 = 16$$

When reset control is used, the heating circulators run continuously while the heating water temperature changes according to actual outdoor temperatures.

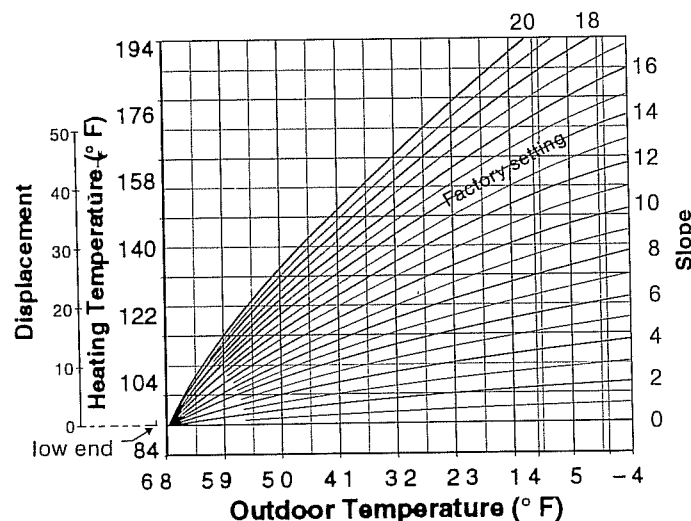

Other features include:

- 2) Solid-state programming of day and night temperature with 84 possible weekly switchpoints.
- 3) Integral safety high-limit aquastat.
- 4) Separate integral manual-reset safety high-limit aquastat.
- 5) Boiler on/off system switch.
- 6) Panel lights indicate operational functions.
- 7) Manual override allows domestic hot water production even when space heating function is turned off (applies only if parallel displacement is set at "0").
- 8) Summer/Winter changeover mode prevents boiler space heating operation when outdoor temperature is above a user-defined point.
- 9) 'Fail-safe' switch overrides electronics in case of malfunction allowing continued use of heating/hot water system.

10) Programmable timer control of an indirect-fired domestic hot water storage tank with recirculation loop. Recirculation and tank loading pump can be programmed separately.

Automatic domestic hot water priority.

When the indirect storage hot water tank calls for heat, the heating circulator(s) are turned off while the tank circulator operates. This is based on the principle that a slight drop in room temperature will not be noticed but a cold shower certainly will! Full boiler capacity is therefore devoted to hot water recovery, and there is no longer a need to oversize boiler capacity to cover both heating and hot water loads. When the tank temperature is satisfied, a post-purge circulator cycle 'dumps' the heat remaining in the boiler (which might otherwise be wasted) into the storage tank. If outdoor temperature is below 34° F, however, the Ecomatic HS 3220 'knows' instead to turn the heating circulator on, sending heat into the living space.

12) Even when the domestic hot water storage tank is turned off, 'Freeze Protection Logic' maintains tank temperature at 41°.

13) If boiler water temperature drops below 90° F while the burner is operating, circulator operation will be disabled until the boiler heats up to temperatures above the boiler dew point. By eliminating condensation, boiler life is increased.

14) In night set-back mode, constant circulation based on the reset curve is disabled. Boiler and circulators are shut-off unless the room sensor detects that the room temperature is too low. In this mode, operation is similar to traditional 'on/off' wall thermostat zoning. However, Ecomatic 'Freeze Protection Logic' forces circulator operation when outdoor temperature is below 34° F. This eliminates any possibility of piping freeze-ups.

Ecomatic Set-up Procedure:

1. As per Ecomatic Installation Guide #C-1, install Ecomatic HS 3220 on boiler, place and wire sensors, connect 120 Volts 60 Hz to control wiring block, circulators, etc. Verify wiring. (When control is powered, Microcomputer Timer Module 071 will display correct time.)
2. Turn off electricity to control before calibrating.
3. Set preferences on individual modules included with the control according to this checklist:
 - **Pg. 4-5: 004 Module Boiler Reset**
 - ◆ Set summer/winter changeover (outdoor temperature at which space heating mode is disabled)
 - ◆ Set heating system reset curve (explanation on page 2)
 - ◆ Set parallel displacement of reset curve
 - Set internal parameters (optional)
 - **Pg 6: 005 Module Mixing Valve Control**
 - ◆ Set mixing valve reset curve (explanation on page 4)
 - ◆ Set parallel displacement of mixing valve reset curve
 - Set internal parameters (optional)
 - **Pg 7: 006 Module DHW Control**
 - ◆ Set DHW temperature
 - Enable thermal disinfection (optional)
 - **Pg 8-9: 071 Module Micro-Computer Timer**
 - **Pg 10-11: Remote User Control**
 - ◆ Choose connection mode
 - **Pg 12-13: Startup Test Procedure**
 - ◆ Verify sensor resistances

The procedures described in this manual must be performed by an authorized Buderus technician. Installation of this control by unauthorized personnel, or any modification of this control not explicitly covered in this manual or approved by Buderus Hydronics Systems, will result in voiding of the factory warranty.

004 Module

BOILER & HEATING CIRCUIT

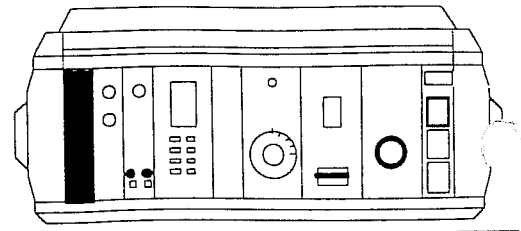

1. General

The 004 Reset Module is a 2-point control that is capable of controlling both boiler operation (burner/operating temperature) and a heating circuit

without mixing valve. Boiler temperature is controlled as a function of outside temperature.

2. Front Panel Settings

1. Summer/Winter Changeover

The slope and the parallel displacement of the heating curve are adjustable to offer finely-tuned control of any heating system.

2. Parallel Displacement

The summer/winter changeover setpoint, which determines the outside temperature at which the system switches from heating/hot water production to hot water production only, can also be set.

3. Slope

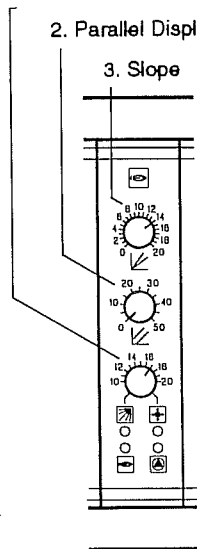

Reset Curve

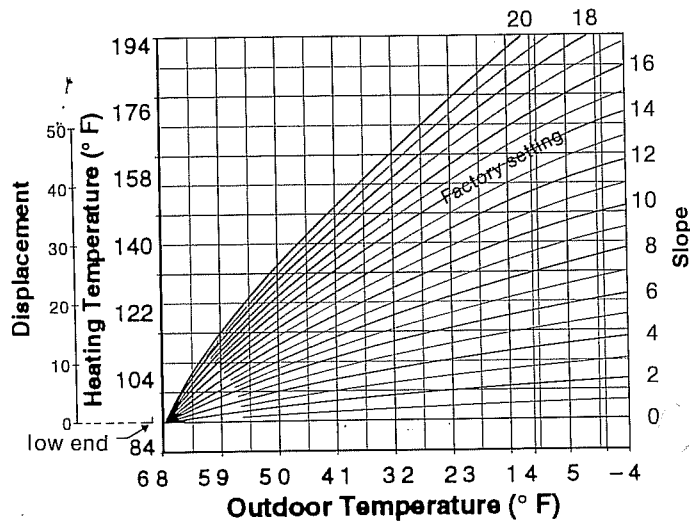

(For further details, see Homeowner's manual)

3. Internal Settings

The 004 module offers the contractor the possibility of changing the factory settings of several Ecomatic control parameters. Four programmable dip switches and a dial located on the module's printed circuit board can be used for this purpose. The board and switches are easily accessed by pulling the module out of the Ecomatic housing.

Use enclosed card puller to remove modules from housing. Failure to do so may result in damage to printed circuit board.

These settings are:

- 1) Maximum boiler operating temperature
- 2) Heating curve starting point
- 3) Minimum boiler operating temperature
- 4) Burner on-off differential
- 5) Night setback water temperature reduction

004 Module Internal Settings

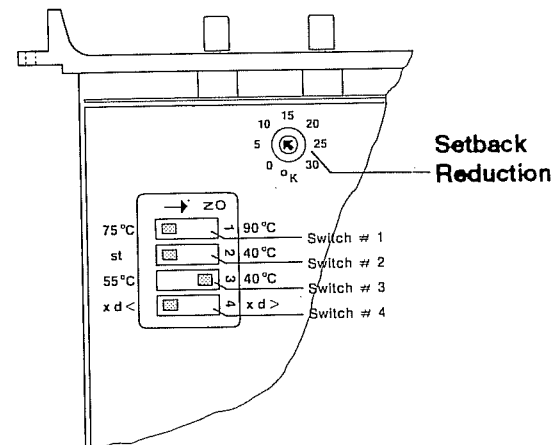

Refer to the following page for detailed instructions

Switch #1: Maximum Boiler Operating Temperature

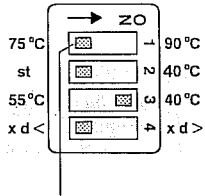

Switch #1

Left position = 75° C. (167° F). (Factory setting)
Recommended for:

- 1) Retrofit applications where existing radiation is oversized
- 2) Sites where outdoor design temperatures are >20 F.

Right position = 90° C. (196° F) Recommended for:

- 1) colder climates
- 2) radiation sized closely to load

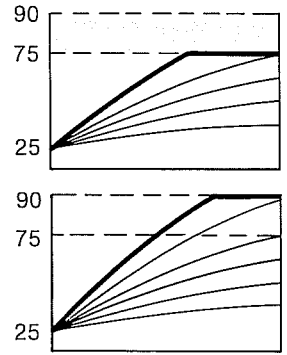

3.2 Switch #2: Heating Curve Starting Point

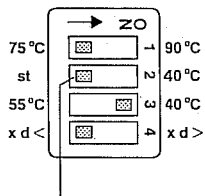

Switch #2

Left position = ST (Factory setting)

Boiler will cool down to room temperature. (Recommended setting)

Right position = boiler maintains minimum 40° C (104° F) permanently.

If this setting is used, switch #3 should be set to 55° C. (131° F.)

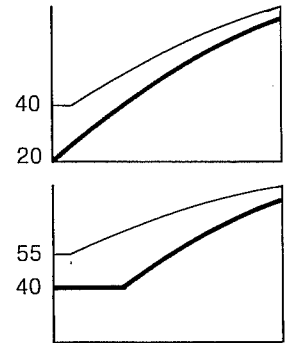

3.3 Switch #3: Minimum Boiler Operation Cycle Temperature:

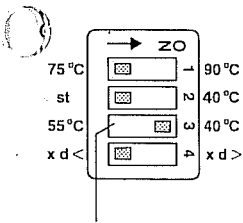

Switch #3

This is the internal temperature that the boiler must reach before the system circulator is enabled.

Right position = 40° C (104° F) (Factory setting)
Suitable for residential heating.

Left position = 55° C (131° F)
Suitable for larger (i.e., commercial) boilers.

Note: If switch #2 is set to the right (40° C.) setting, switch #3 must also be moved to the left (55° C.) setting.

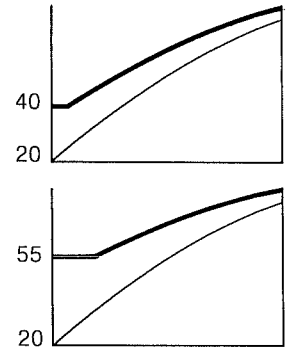

3.4 Switch #4: Burner on-off Differential (Variable):

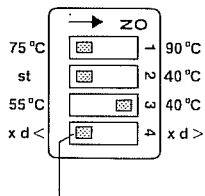

Switch #4

Right position = xd < (Factory setting)

Burner on/off cycle differential varies from 18° F (10° C) at outdoor temperature of 59° F (15° C) to 7° F (4° C) at 5° F. (-15° C).

Left position = xd >

Burner differential varies from 27° F (15° C) at outdoor temperature of 59° F (15° C) to 7° F (4° C) at 5° F. (-15° C)

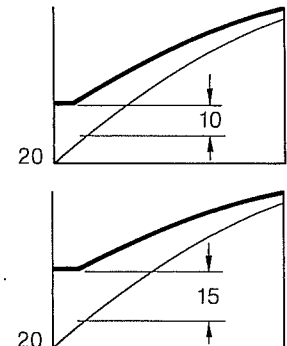

3.5 Reduction of Heating Curve During Night Setback Mode:

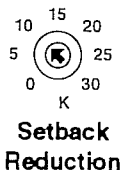

Determines downward parallel shift from the daytime (normal) heating curve.

Factory setting = 10° K. (18° F.)

This can be adjusted from zero difference (night setback identical to normal mode) to 30° K (54° F = maximum possible setback).

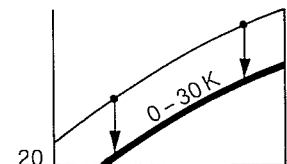

005 Module

MIXING VALVE CONTROL

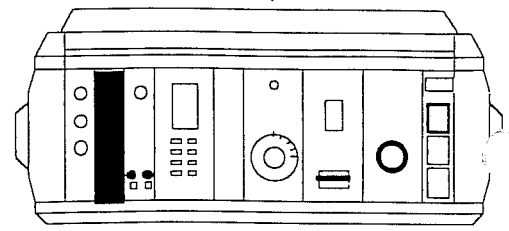

1. General

The 005 module is a stepless three-point control that can modulate boiler temperature as well as a three or four-way mixing valve. Module output to mixing valve = 110 V AC 60 Hz.

2. Front Panel Settings

1. Parallel Displacement
2. Slope

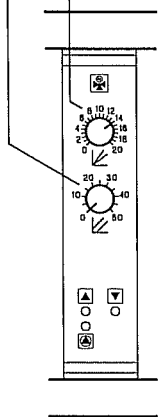

Slope and parallel displacement of the heating curve for a mixing valve controller are adjustable to offer finely-tuned control of any heating system.

When mixing valve is used to control radiant floor heating, this curve would typically be set between 6 and 10.

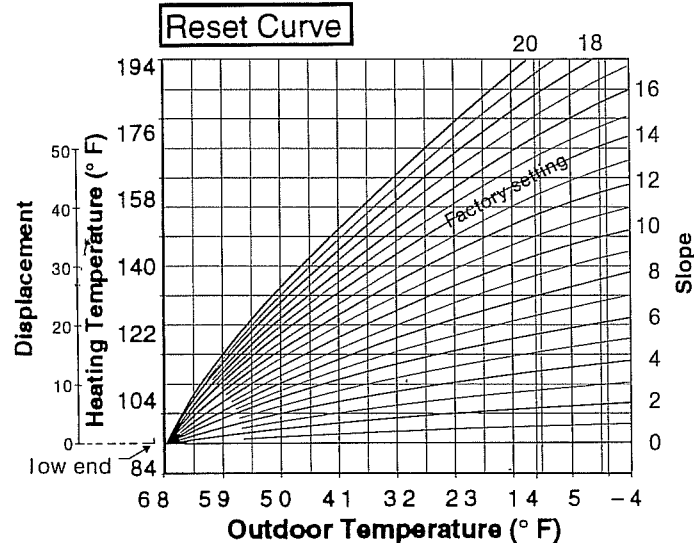

3. Internal Settings

The 005 module offers the contractor the option of changing the factory settings of several of the Ecomatic control parameters. Dip switches located on the module's printed circuit board can be used for this purpose.

Use enclosed card puller to remove modules from housing. Failure to do so may result in damage to printed circuit board.

3.1 Switch #1: Circulator Logic Abled/Disabled

This setting should not be changed from factory setting

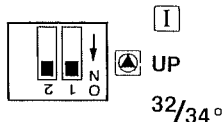

'32/34°': Circulator logic 'on' (Factory setting): Mixing valve circulator is 'off' when heating water temperature is less than 90° F (32° C) while the burner is running. When heating water temperature is above 93° F (34°C), mixing valve circulator is 'on' when burner is running.

Setting 'I': Circulator logic 'off': do not change factory setting.

3.2 Domestic Water Heating Priority

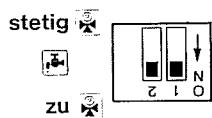

'Zu' (closed): (Factory setting) Mixing valve closes while domestic water is heated. Mixing valve circulator continues operating.

'Stetig' (priority override): Mixing valve operates normally during the domestic hot water heating cycle.

3.3 Reduction of Heating Curve During Night Setback Mode:

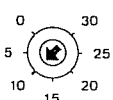

Determines downward parallel shift of daytime (normal) heating curve. **Factory setting = 10° K. (18° F.)** Can be adjusted from zero difference (night setback identical to normal mode) to maximum 30° K (54° F).

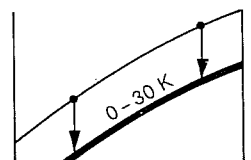

005 Module Circuit Board Settings

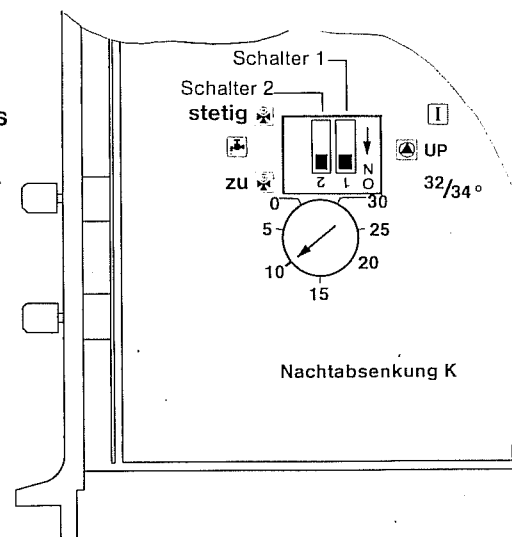

006 Module

DOMESTIC WATER HEATING CONTROL

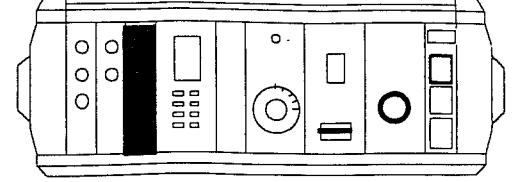

1. General

The 006 Module regulates the function of a Buderus Isocal hot water storage tank connected to a heating boiler. It electronically grants priority to domestic hot water production (over space heating 004 or 005 module functions) whenever there is a call for hot water production. Maximum boiler temperature during a call for hot water is different than the heating temperature found on the heating curve. It can be set independently on the 006 circuit board.

2. Front Panel Settings

The 006 module is set at the factory to limit hot water temperature to 140° F. If higher hot water temperatures are required (up to 176° F), proceed as follows:

- 1) Remove 006 module from housing using card puller.
- 2) Carefully break off plastic stopper at rear of temperature adjustment knob. (Fig. 006.2)
- 3) Replace module. Adjust to desired temperature.

3. Installer Settings For Thermal Disinfection Mode

3.1 Switch S2: Activate/Deactivate Thermal Disinfection

Open position = 'no thermal disinfection' (Factory Setting)

Closed position = thermal disinfection activated

(Jumper installed)

With thermal disinfection activated, it is necessary to choose either channel K4 or K5 from switch S1. (See below.)

3.2 Switch S1: Channel Selection

The 006 module is delivered with this switch in its K5 setting. If thermal disinfection has been activated, set S1 as follows:

Setting K4: Allows timer programming of thermal disinfection on channel 4 of timer module. If a recirculation pump is connected on channel 4, it will operate at this time. Other heating controls, such as normal recirculation pump timed operation or a second mixing valve cannot be controlled by this channel if K4 is selected. (Timer channels, see section 071).

Setting K5 (Factory Program): Thermal disinfection is enabled for one hour, Monday nights from 10 PM –11 PM. This channel is not user-programmable and will not display on the timer module.

Maximum heating water temperature of domestic hot water heating can be set on the 006 module. Factory setting is 90° C / 194° F. If lower heating water temperature is required, proceed as follows:

- a) Remove 006 module from housing using card puller.
- b) Set knob "P" at desired temperature; 50° C = 122° F, 60° C = 140° F, 70° C = 158° F, 80° = 176° F.

NOTE: setting on knob "P" must at any time be minimum 5 K / 9° F higher than the desired domestic hot water temperature.

3. Replace module.

006 MODULE CIRCUIT BOARD

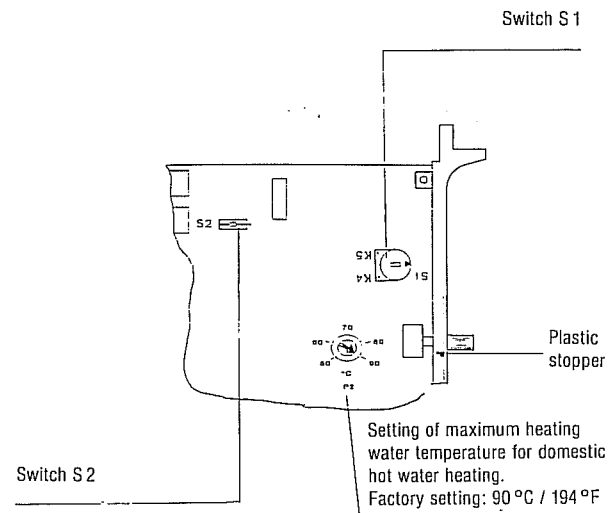

About Thermal Disinfection

To eliminate the bacteria known to cause Legionnaire's Disease, it is desirable to raise the domestic hot water storage tank temperature to a certain level (>160° F) periodically. The 006 module can be programmed to operate a periodic thermal disinfection routine using one of two modes.

In either mode, the boiler is heated to its maximum operating temperature (i.e., 175–195° F) while the storage tank circulator and the recirculation circulator (if used) are forced to operate. To be effective, the global storage tank water temperature must be greater than 167° F at the end of the disinfection cycle.

Effective disinfection is a function of:

- boiler capacity
- heat exchanger capacity of the domestic storage tank
- water content of the storage tank
- configuration of the recirculation loop

During the disinfection process, internal tank temperature is measured by the Ecomatic, and the process is not halted until disinfection is finished.

If the factory program (set in channel 5—see paragraph 3.2 above) is not sufficient, or if other intervals are desired for special applications, the user-programmable channel 4 allows custom setting of time and duration.

Note: the time period chosen for disinfection should be such that no domestic hot water will normally be drawn off for a period of two hours. For this reason, and because full boiler capacity is more likely to be available, it is advisable to disinfect during a night setback period.

Hot water piping should be rated for the temperatures obtained in the thermal disinfection process before activating this mode. Anti-scald devices should be placed at the hot water tank outlet, or at the individual fixtures.

071 Module

MICRO-COMPUTER TIMER

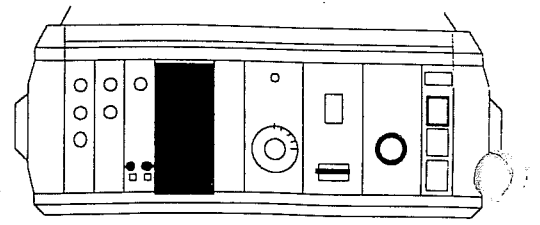

1. General

The solid-state timer incorporated into the Ecomatic 3220 controls all the timed heating functions discussed in this manual. There are 84 independent programmable switchpoints available.

The correct time is set at the factory and will appear in 24-hr mode on the LCD display as soon as the Ecomatic is electrically connected. At startup, the standard factory setback program (see section 2.2) is activated. This program may be partially or completely overwritten by the end-user.

In case of power failure, the LCD display will blank out, but the backup battery incorporated in the timer module safeguards all program information.

2. Front Panel Settings

Please refer to the Homeowner's Manual for detailed instructions on programming the 071 Module timer for those cases where the factory-set program is inappropriate. The "O" (for 'off' or 'setback') and "I" (for 'on' or 'normal') symbols at the bottom of the LCD display indicate the status of the four available programmable channels (burner, mixing valve, domestic hot water, and recirculation (or mixing valve 2)), whose labels are placed immediately below the display.



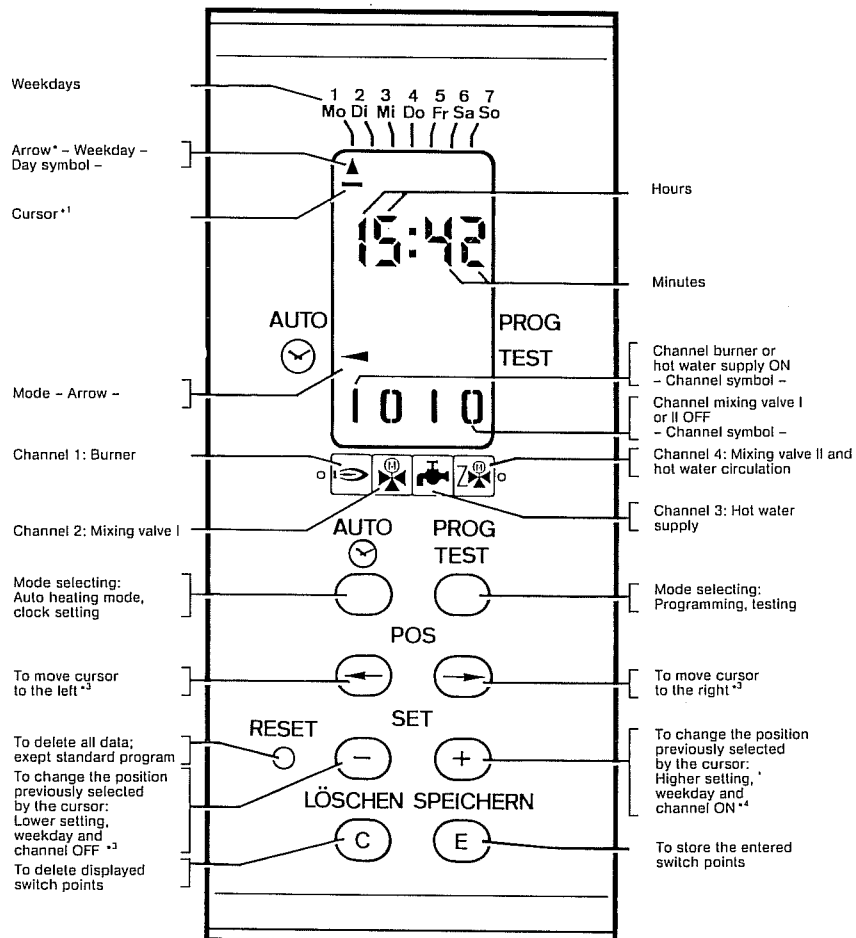

Mo = Monday Di = Tuesday Mi = Wednesday Do = Thursday Fr = Friday Sa = Saturday So = Sunday

12 A.M.	0
1	→ 1
2	→ 2
3	→ 3
4	→ 4
5	→ 5
6	→ 6
7	→ 7
8	→ 8
9	→ 9
10	→ 10
11	→ 11
12 P.M.	12
1	→ 13
2	→ 14
3	→ 15
4	→ 16
5	→ 17
6	→ 18
7	→ 19
8	→ 20
9	→ 21
10	→ 22
11	→ 23



Internal Settings

Four user-programmable channels have been factory-assigned as follows:

- Channel 1  = Boiler Circuit (HK 1)
- Channel 2  = Mixing Valve Circuit
- Channel 3  = Domestic Water Heating
- Channel 4 = Domestic Water Recirculation Pump and Mixing Valve circuit 2 (HK III)
- Channel 5  = Factory program:
Not user-programmable

If necessary, this channel allocation can be modified by cutting the existing wire jumpers on the BR1 to BR5 bridges on the module's circuit board (accessible by removing the 071 module from the Ecomatic housing), and connecting new shunts in the desired configuration.

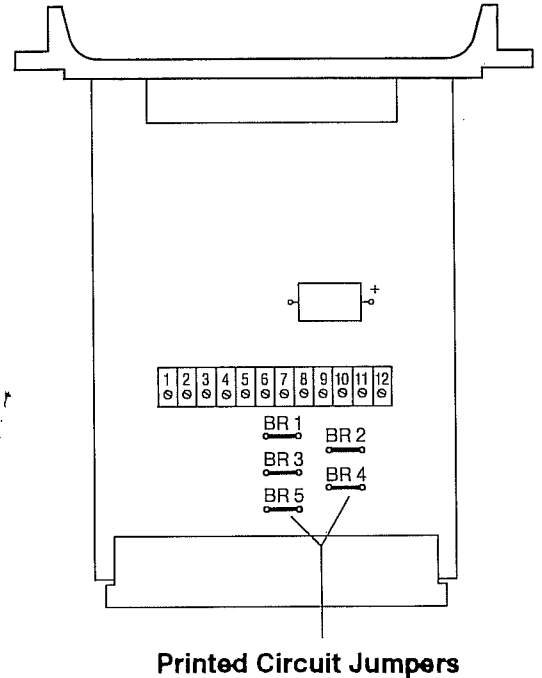

figure 7.1

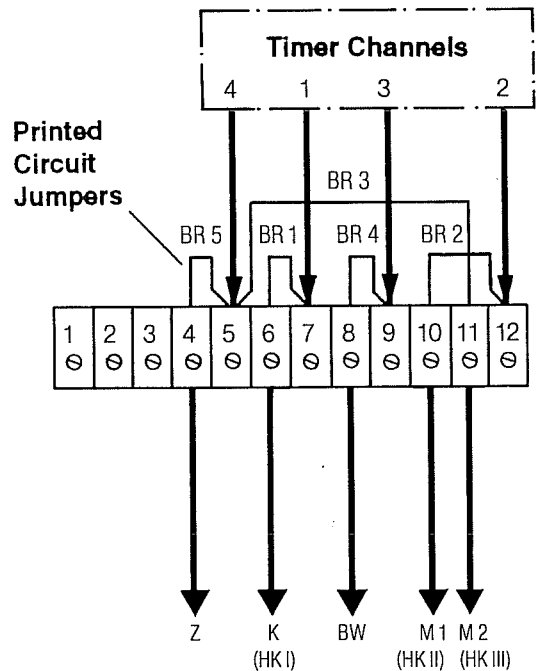

figure 7.2 To Heating Circuits

1. General

The remote user control with integral room temperature sensor allows the building occupants to set the normal and setback heating mode room temperatures as well as choosing to override either mode when desired. It incorporates a temperature sensor that enables the Ecomatic 3220 to compensate for short term internal heat gains or losses.

The R.U.C. should not be installed in a sunny location, behind curtains, near radiation, or in any other situation where the temperature sensor might be exposed to 'false' readings.

2. Settings

Temperature Settings (left side slide controls)

- = normal heating temperature selection (daytime mode)
- = setback heating temperature selection (nighttime mode)

Temperature Selection

Mode settings (bottom right switch)

- = continuous normal heating
- = continuous setback heating
- = automatic timer operation

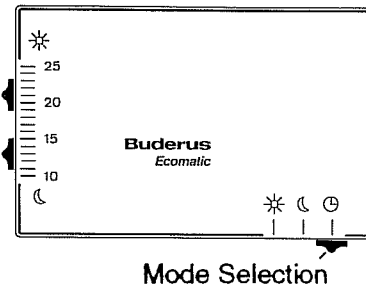

(Note: Temperature scales on control are approximate values only)

Note: These settings do not influence domestic hot water production

3. Mode Logic

Daytime Heating Mode

The room temperature sensor controls room temperature by shifting the heating curve. The desired temperature is constantly compared with the actual temperature. Proportional shifts in the heating curve are made to correct any measured difference between the two. The Ecomatic 3220 control logic compensates for any short term internal heat gains or losses that might occur (solar gain, fireplace, lamps, drafts, etc.). If Room Temperature Compensation is disabled (see section 4), proportional shifts in the heating curve are not made. In daytime mode, heating circulators run constantly.

Nighttime Setback Mode

In nighttime mode, the room temperature sensor directly controls room temperature by on/off boiler-circulator operation. The boiler and circulators will not operate unless the actual room temperature falls below set room temperature.

Note: At outdoor temperatures below 34° F, the heating circulators will run continuously in nighttime mode as anti-freeze protection. The boiler, however, still only operates when actual room temperature falls below set room temperature.

4. Connection Options

Connection model 1: Room Temperature Compensation enabled.

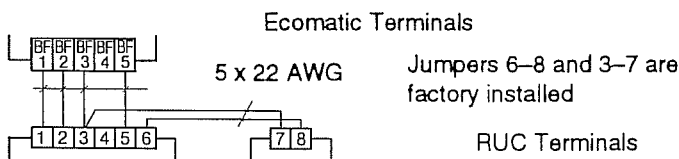

Connection model 2: Room Temperature Compensation disabled.

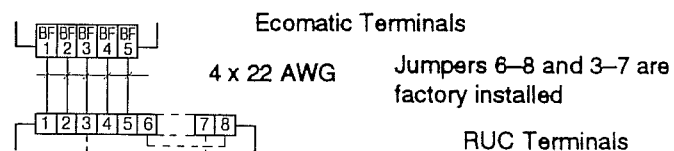

Connection model 3: Room Temperature Compensation enabled. Remote sensor location.

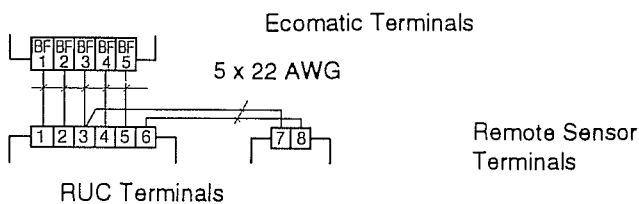

Connection model 4: Room Temperature Compensation disabled. Remote sensor location.

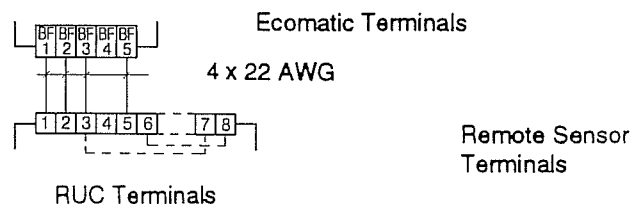

Procedure for Operation without Remote User Control

If it is necessary to operate the Ecomatic 3220 without the remote user control the following procedures should be used:

Ecomatic Terminals

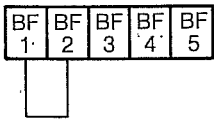

OPTION A): Connect jumper between BF 1 and BF 2 on printed circuit board.

Control logic if 004 Module is principle controlling module:

Boiler stays in operation during nighttime setback mode at an adjustable parallel displacement downward (0 – 54°F) from daytime curve. Circulator runs continuously.

Control logic if 005 Module is principle controlling module:

Mixing valve motor is activated during nighttime setback mode at an adjustable parallel displacement downward (0 – 54° F) from daytime curve. Circulator runs continuously.

Ecomatic Terminals

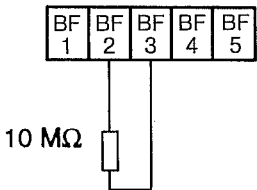

OPTION B): Connect 10 MΩ resistor between BF 2 and BF 3.

Control logic with 004 Module as principle controlling module:

In nighttime setback mode, the boiler and burner are turned off completely, except when there is a call for heat from a mixing valve circuit. Circulator runs only when outdoor temperatures fall below 34° F.

6. Partial Use Configurations for Remote User Control

Ecomatic Terminals

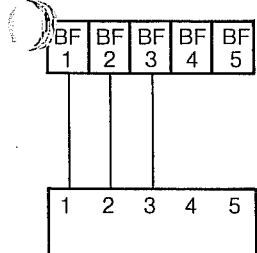

Certain R.U.C. functions can selectively be made active or inactive.

OPTION A): Connection of the remote user control for nighttime setback mode only.

Mode selector and day mode temperature selector switches are disabled.

Ecomatic Terminals

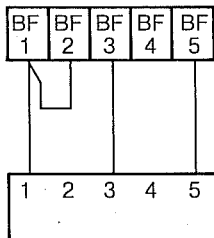

OPTION B): Connection of the remote user control for use as mode selector only.

Both temperature selector switches are disabled

Ecomatic Terminals

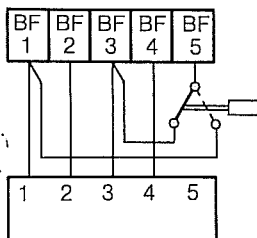

OPTION C): Connection of the remote user control with Room Temperature Compensation enabled in nighttime setback mode and remote activation of day/night mode.

Terminals 1 – 5: Day mode
R.U.C. Terminals 3 – 5: Night mode

In this mode, Ecomatic functions are controllable by remote computer via modem. (Consult factory.)

1. Verify Sensor Readings

Measure temperature at sensor locations. With power off at the Ecomatic, use an ohmmeter to verify sensor resistances. Sensor tolerances are $\pm 4^\circ\text{F}$

1.1. Outdoor Sensor Curve

Take measurements at end of cable FA 1 and 2.

Note: If 3-cable sensor is used, resistances will be the double of anticipated values.

3-Cable
Sensor

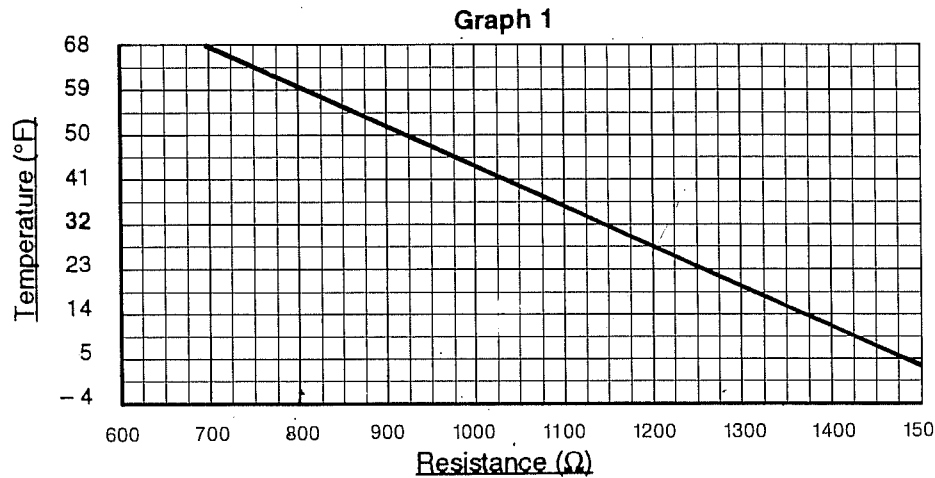

1.2. Boiler Supply, Flow, Return, and Domestic Hot Water Sensors

Take measurements at end of cables FK 1-2, FV 1-2, FR 1-2, and FB 1-2 respectively.

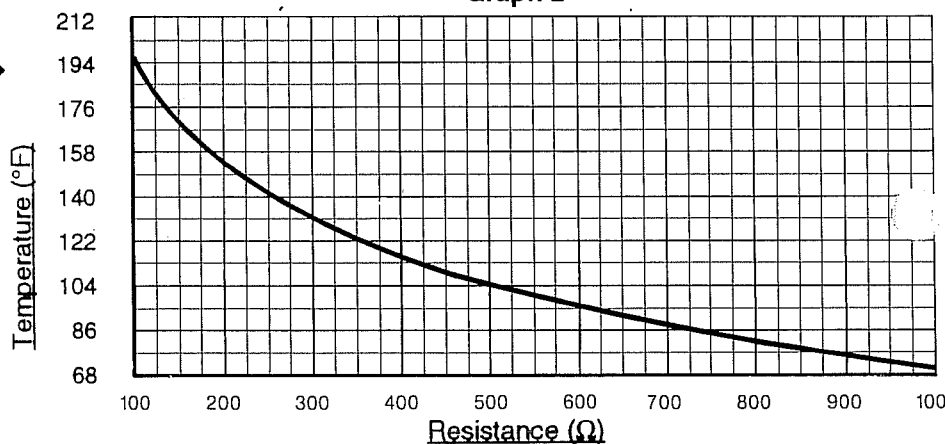

1.3. User Remote Control Curve

1.3.1 Room Temperature Sensor: With R.U.C. mode selector on day mode, sensor resistance should match values from graph 3.

1.3. Mode Selection Switch: With R.U.C. mode selector switch set on corresponding mode, measure resistance at Ecomatic terminals 1 and 5.

Position ☀ = $\sim 32.5\text{ K}\Omega$

Position ☾ = $\sim 30\text{ K}\Omega$

Position ☾ = $\sim 31\text{ K}\Omega$

1.3.3 Temperature Selection Switch: With R.U.C. mode selector on day mode and daytime temperature selector set at actual room temperature, the resistance values between Ecomatic terminals BF 1-4 and BF 3-4 should be identical ($\pm 50\ \Omega$).

With R.U.C. mode selector on nighttime mode and nighttime temperature selector set at actual room temperature, the resistance values read between Ecomatic terminals BF 1-2 and BF 2-3 should be identical ($\pm 50\ \Omega$).

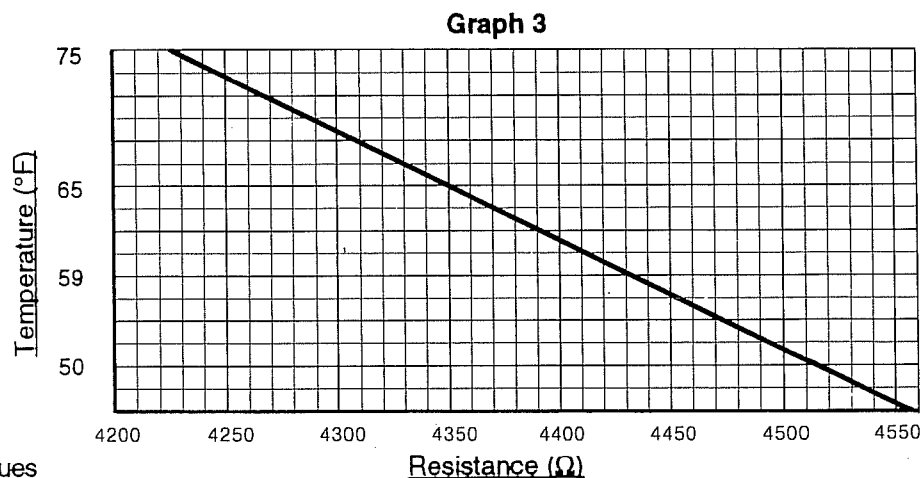

2. Verification of the STB/Manual High Limit

A) Procedure for all G - Series boilers and G224E Models #73 and Larger:

1. Disconnect space heating circulators from Ecomatic HS 3220 by unplugging PH - HK1 terminals from wiring block at rear of control.
- Remove STB manual reset high-limit cover cap.
2. Restore electrical power to Ecomatic.
3. Remove aquastat dial button.
4. Start boiler by setting "Flue gas test/emergency operation" switch to 'manual' position.
5. With a small screwdriver or similar tool, depress and hold green button (figure 3). This action bypasses the operating limit function..
6. While maintaining pressure on green button, allow boiler to reach 110° C/230° F temperature. At this point, the manual reset high-limit button located under the STB screw cap will activate and the burner will shut off.
7. Reconnect and operate space heating circulators until boiler temperature drops to 90° C (194° F). Reset STB reset button. Screw on STB cover cap.
8. Replace aquastat dial button. Restore dial setting to desired operating high-limit (i.e., 90° C/194° F) to resume automatic operation.
9. Return "Flue gas test/emergency operation" switch to 'aut'.

A) Procedure for G 224E Models #17 through 64:

Follow the same procedure outlined above, but make sure that the high limit setting located in the Honeywell L4148E control (provided as standard equipment on all Buderus G224E gas boilers up through model #64) is slightly higher than the 110° C/230° F setting on the STB.

STB Cover Button
High Limit Reset

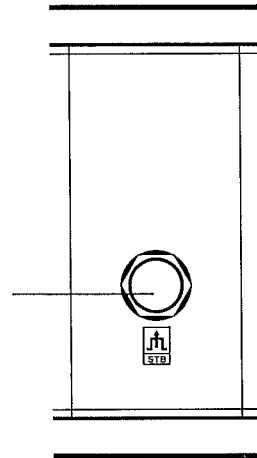

Aquastat Dial Cover

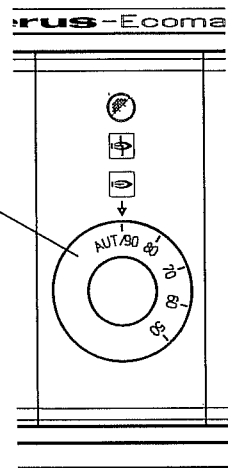

Dial

Lever

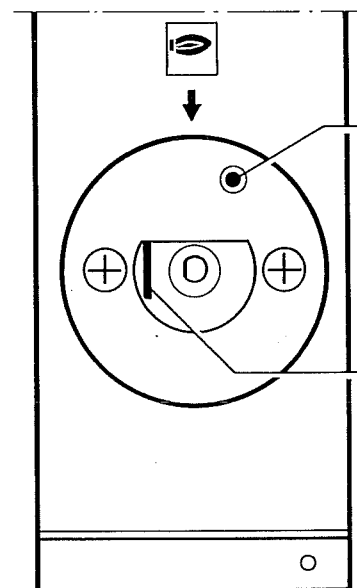

Degrees Centigrade to Degrees Fahrenheit

DEGREES CENTIGRADE TO DEGREES FAHRENHEIT

C	F	C	F	C	F
-40	-40.0	+ 10	+ 50.0	+ 50	+ 122.0
-38	-36.4	+ 11	+ 51.8	+ 55	+ 131.0
-36	-32.8	+ 12	+ 53.6	+ 60	+ 140.0
-34	-29.2	+ 13	+ 55.4	+ 65	+ 149.0
-32	-25.6	+ 14	+ 57.2	+ 70	+ 158.0
-30	-22.0	+ 15	+ 59.0	+ 75	+ 167.0
-28	-18.4	+ 16	+ 60.8	+ 80	+ 176.0
-26	-14.8	+ 17	+ 62.6	+ 85	+ 185.0
-24	-11.2	+ 18	+ 64.4	+ 90	+ 194.0
-22	- 7.6	+ 19	+ 66.2	+ 95	+ 203.0
-20	- 4.0	+ 20	+ 68.0	+ 100	+ 212.0
-19	- 2.2	+ 21	+ 69.8	+ 105	+ 221.0
-18	- 0.4	+ 22	+ 71.6	+ 110	+ 230.0
-17	+ 1.4	+ 23	+ 73.4	+ 115	+ 239.0
-16	+ 3.2	+ 24	+ 75.2	+ 120	+ 248.0
-15	+ 5.0	+ 25	+ 77.0	+ 125	+ 257.0
-14	+ 6.8	+ 26	+ 78.8	+ 130	+ 266.0
-13	+ 8.6	+ 27	+ 80.6	+ 135	+ 275.0
-12	+ 10.4	+ 28	+ 82.4	+ 140	+ 284.0
-11	+ 12.2	+ 29	+ 84.2	+ 145	+ 293.0
-10	+ 14.0	+ 30	+ 86.0	+ 150	+ 302.0
- 9	+ 15.8	+ 31	+ 87.8	+ 155	+ 311.0
- 8	+ 17.6	+ 32	+ 89.6	+ 160	+ 320.0
- 7	+ 19.4	+ 33	+ 91.4	+ 165	+ 329.0
- 6	+ 21.2	+ 34	+ 93.2	+ 170	+ 338.0
- 5	+ 23.0	+ 35	+ 95.0	+ 175	+ 347.0
- 4	+ 24.8	+ 36	+ 96.8	+ 180	+ 356.0
- 3	+ 26.6	+ 37	+ 98.6	+ 185	+ 365.0
- 2	+ 28.4	+ 38	+ 100.4	+ 190	+ 374.0
- 1	+ 30.2	+ 39	+ 102.2	+ 195	+ 383.0
± 0	+ 32.0	+ 40	+ 104.0	+ 200	+ 392.0
+ 1	+ 33.8	+ 41	+ 105.8	+ 205	+ 401.0
+ 2	+ 35.6	+ 42	+ 107.6	+ 210	+ 410.0
+ 3	+ 37.4	+ 43	+ 109.4	+ 215	+ 419.0
+ 4	+ 39.2	+ 44	+ 111.2	+ 220	+ 428.0
+ 5	+ 41.0	+ 45	+ 113.0	+ 225	+ 437.0
+ 6	+ 42.8	+ 46	+ 114.8	+ 230	+ 446.0
+ 7	+ 44.6	+ 47	+ 116.6	+ 235	+ 455.0
+ 8	+ 46.4	+ 48	+ 118.4	+ 240	+ 464.0
+ 9	+ 48.2	+ 49	+ 120.2	+ 245	+ 473.0