



Climate 5000 Series 18K BTU Multi Zone Hyper Heat Outdoor Unit – Ducted

Engineering
Submittal
Sheet



BOSCH

Overview and Project Information	
  	Project Name
	Location
	Architect
	Engineer
	General Contractor
	Reference #
	Date

18K Btu Multi Zone Hyper Heat Outdoor Unit - Ducted		
Indoor model #	8733953102 (Qty 2)	
Indoor model name	BMS500-AAU009-1AHDXB (Qty 2)	
Outdoor model #	8733953119	
Outdoor model name	BMS500-AAM018-1CSXHB	
Performance Data		
Cooling	Capacity (Btu/h):	18000
	Input (W)	1636
	Rated current (A)	7.1
	EER (Btu/w)	11.0
	SEER (Btu/w)	18.0
Heating at 47°F	Capacity (Btu/h)	19000
	Input (W)	1600
	Rated current (A)	7.0
	COP (W/W)	3.48
	HSPF4	9.8
	HSPF5	8.4
Electrical Data		
Power supply (V / Ø / Hz)	208-230 / 1 / 60	
Min. Circuit ampacity (A)	25.0	
Max. Fuse (A)	35.0	
Compressor Data		
Type:	Twin-Rotary	
Refrigerant oil /oil charge (ml)	ESTER OIL VG74 / 670	
Input (W)	1970	
Rated current (RLA / A)	20.00	
Operation Range		
ODU	Cooling (°F / °C)	-22~122 / -30~50
	Heating (°F / °C)	-22~86 / -30~30

Piping		
Refrigerant precharge (ft / m)	49 / 15	
Refrigerant charge (oz / g)	98.8 / 2801	
Additional charge per ft (oz)	0.161	
Liquid side (in / mm)	2 X 1/4" / Ø6.35	
Gas side (in / mm)	2 X 3/8" / Ø9.52	
Max. refrigerant pipe length (ft / m)	131 / 40	
Max. length to one IDU (ft / m)	82 / 25	
Max. height difference between IDU and ODU (ft / m)	49 / 15	
Max. height difference between IDU's (ft / m)	33 / 10	
System Data		
Refrigerant Type	R410A	
Design pressure (PSIG)	550/340	
Dehumidification (pts/hr)	3.79	
ODU	Fan motor qty (ea)	1
	Fan motor input (W)	150.0
	Fan motor RLA (A)	1.39
	Fan motor speed, H / M / L (RPM)	900 / 750 / 600
	Air flow, Max (CFM)	2129
	Noise level, Max (dB(A))	63.4
	Net weight (lbs / kg)	149.9 / 68.0
	Gross weight (lbs / kg)	160.9 / 73.0
IDU	Minimum # of indoors	2
	Maximum # of indoors	2

Climate 5000 Series
 18K Btu Multi Zone Hyper Heat Outdoor Unit – Ducted



Outdoor Unit Dimensions and Connections

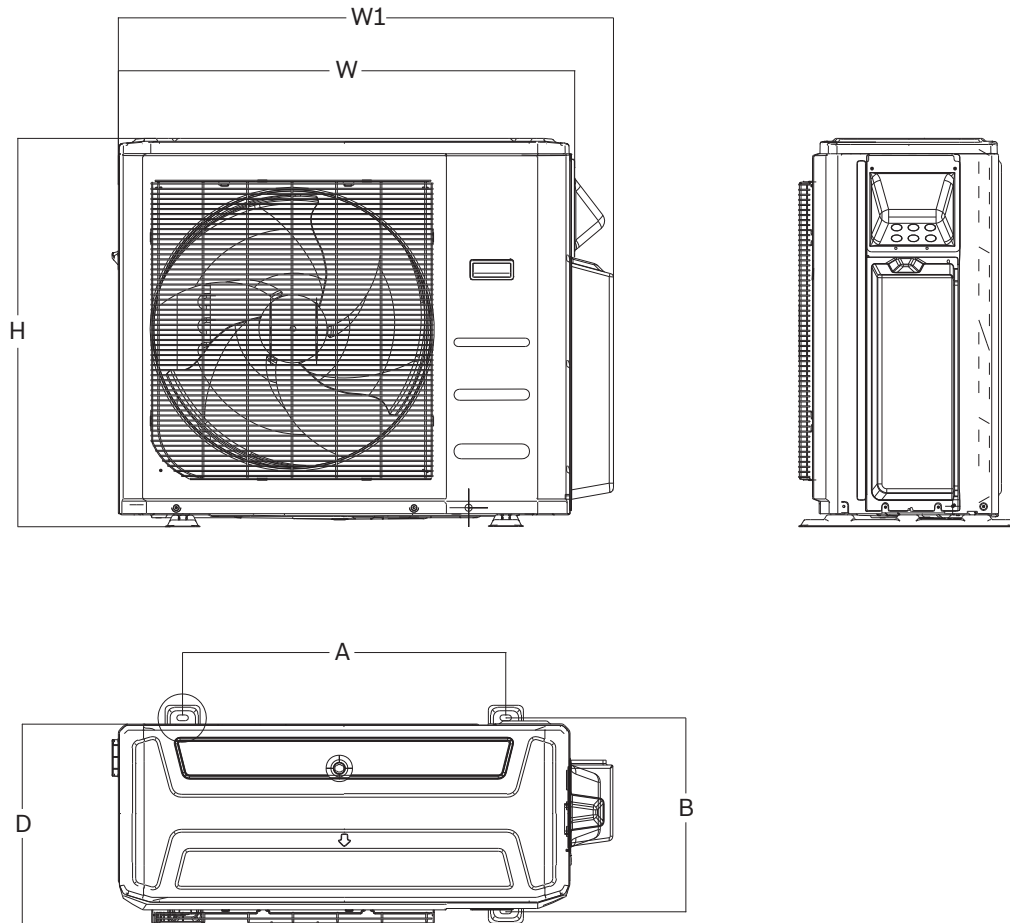

Model	W (in)	D (in)	H (in)	W1 (in)	A (in)	B (in)
BMS500-AAM018-1CSXHB	37.2	16.5	31.9	40.6	26.5	15.9