

G615/11 Cast Iron Boiler

Engineering
Submittal
Sheet

Buderus

Boiler Overview

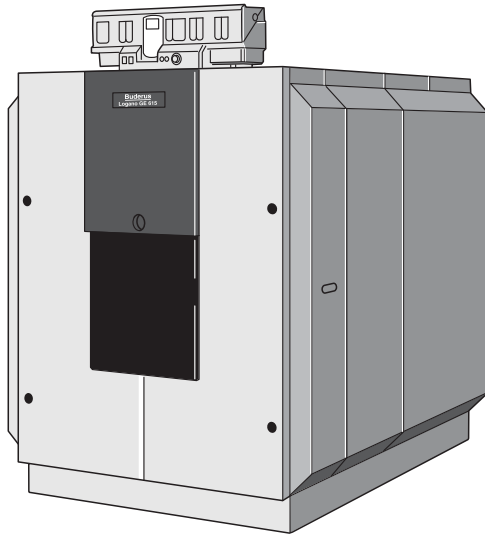

Engineering Specifications

There shall be provided and installed __ G615-11 Buderus sectional cast iron hot water boiler(s), suitable for forced draft firing with fuel oil #2, natural gas or propane.

Boiler(s) shall be fabricated with GL-180M high silicon cast iron. They shall be of pressurized wet base, double wall, sectional construction with precision machined steel push nipples. Boiler(s) shall have a central return stainless steel distribution pipe with two drilled openings per boiler section to allow proportionate water distribution over the entire length of the boiler.

Boiler(s) shall be constructed, tested and labeled in accordance with ASME Section IV and shall bear IBR ratings and the ASME stamp. Sections shall be labeled for 87psig maximum working pressure.

Boiler(s) shall be of full three pass design, suitable for forced draft firing and capable of achieving combustion efficiencies of 86% for oil firing and 84% for gas firing. Gross stack temperatures at full firing rate shall not exceed 400°F.

The design of the boiler and the geometry of the combustion chamber shall eliminate the need for refractory material or a combustion target wall. Boiler flue collector shall be cast iron construction for long life.

Access to boiler firesides for inspection and maintenance shall be through a fully insulated and jacketed door, field-adjustable for left or right hinging. The seal between the door and the boiler casing shall be a permanent dry gasket for repeated positive sealing.

Boiler(s) shall be furnished with removable flue passage baffles to easily alter gross stack temperatures.

Boiler shall have no minimum return water temperature and no minimum flow requirement.

Boiler(s) shall not require any means of return water temperature control or minimum flow condition.

G615/11
Cast Iron Boiler



Performance Data		
	Unit	Value
Boiler sections	Each	11
Oil input	GPH	21.00
Gas input	MBtu/h	3031
Rated gross output	MBtu/h	2532
IBR Rating	MBtu/h	2202
Boiler horsepower	H.P.	75.6
AHRI Natural gas combustion efficiency	%	84.0
AHRI Natural gas thermal efficiency	%	83.5
AHRI Oil combustion efficiency	%	86.6
AHRI Oil thermal efficiency	%	86.1

General Data		
	Unit	Value
Boiler category	-	Non-Condensing
Heat exchanger construction	-	Cast Iron
Heating surface	Sq. Ft.	314.90
Maximum allowable working pressure	PSIG	87
Water content	Gallons	176.00
Weight - shipping (approx.)	Lbs	6580
Weight - operating (approx.)	Lbs	8050
Standard relief valve size (inlet x outlet)	Inch	1¼ x 1½
Standard relief valve pressure rating (other capacities available upon request)	PSI	50
Minimum relief valve capacity	MBH	2532
Venting category (stack design will determine applicable category)	-	-

Operational Data		
	Unit	Value
Fireside pressure drop	Inch W.C.	1.3
Required vent connection pressure	Inch W.C.	0.1
Maximum allowable firebox pressure	Inch W.C.	2.0
Minimum flow rate	GPM	none
Maximum flow rate	GPM	none
Maximum supply water temperature	°F	248
Minimum return water temperature	°F	none

Burner Data		
	Unit	Value
Allowable fuels	-	Natural gas, LP, Oil#2
Motor voltages, gas/oil pressure and modes of operation will vary based upon final burner selection - see burner specification sheet for additional details	-	-

Approval Data	
Approval description	Approval number
Massachusetts Approval #	G3-0610-523
New York MEA #	MEA 67-01-E
CRN #	1529.9C

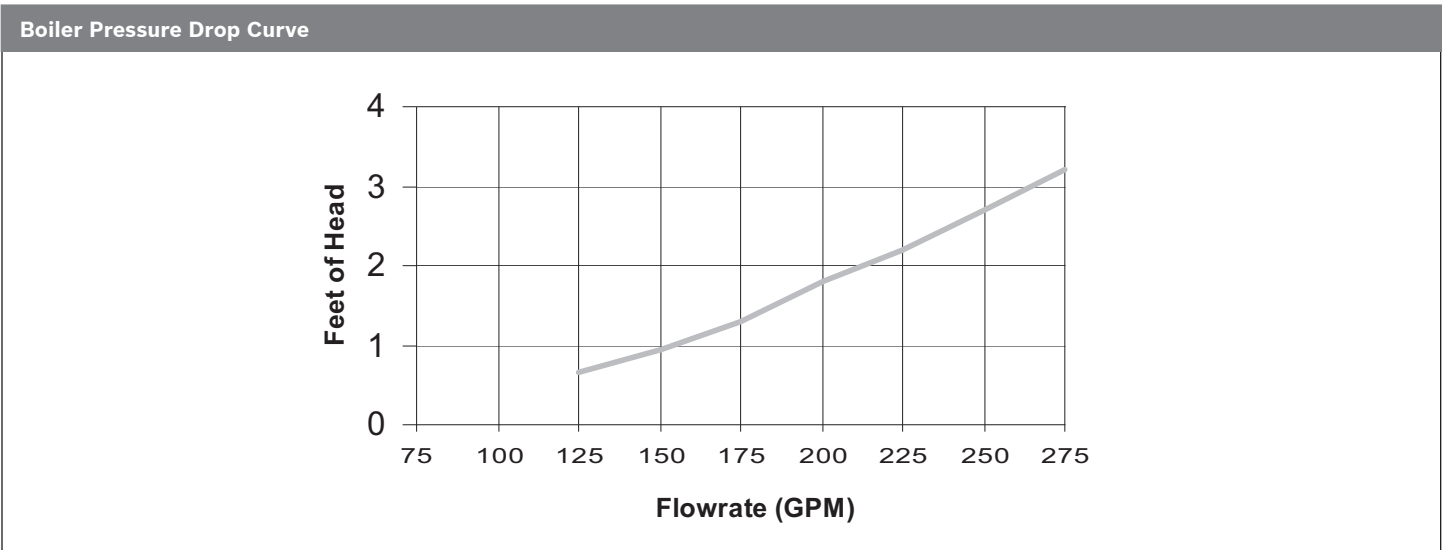

Boiler Dimensions and Connections

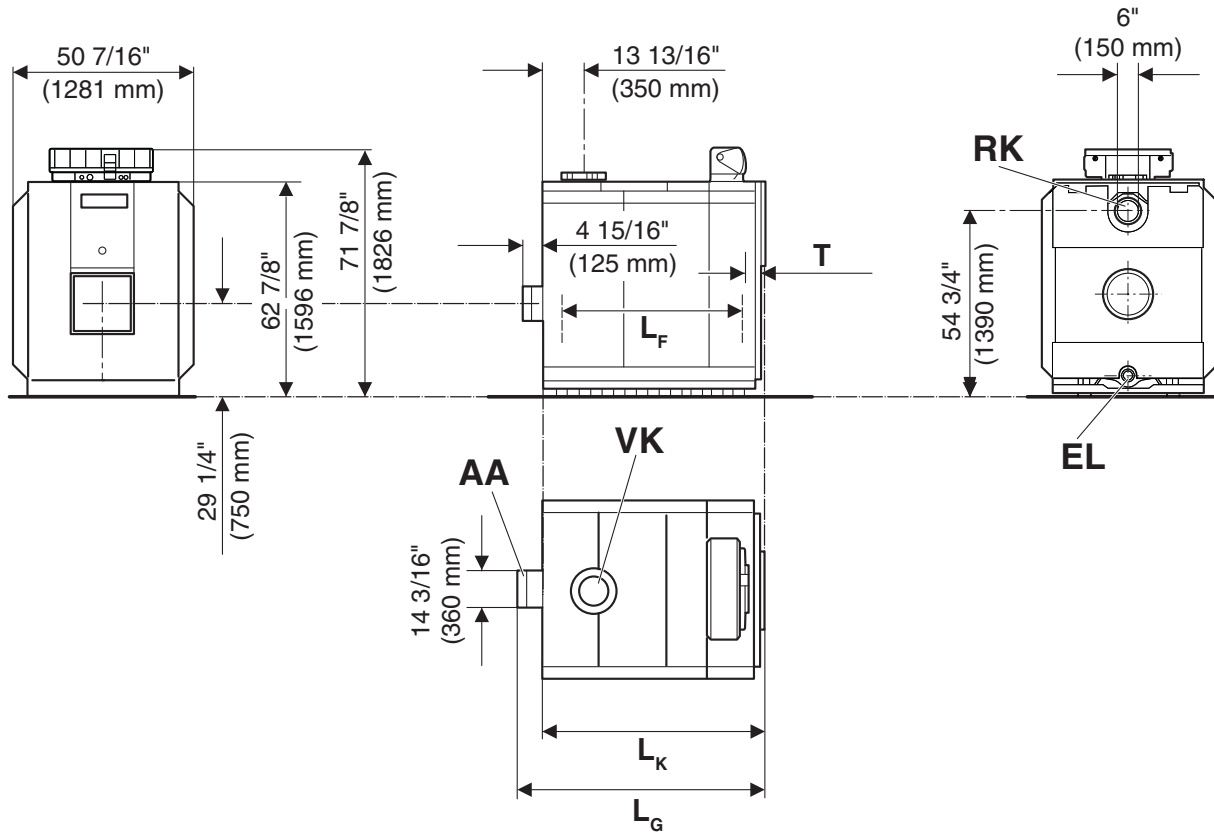

Boiler Dimensions / Connections Data

Item	Description	Unit	Value
RK	Boiler return	Inch	6
VK	Boiler supply	Inch	6
EL	Boiler drain	Inch	3/4
LG	Boiler length including jacket	Inch	89 1/4
LK	Boiler block length	Inch	84 1/2
LF	Fire box depth	Inch	73 1/2

* All dimensions above are within +/- 1/4".

Supply Manifold Connections

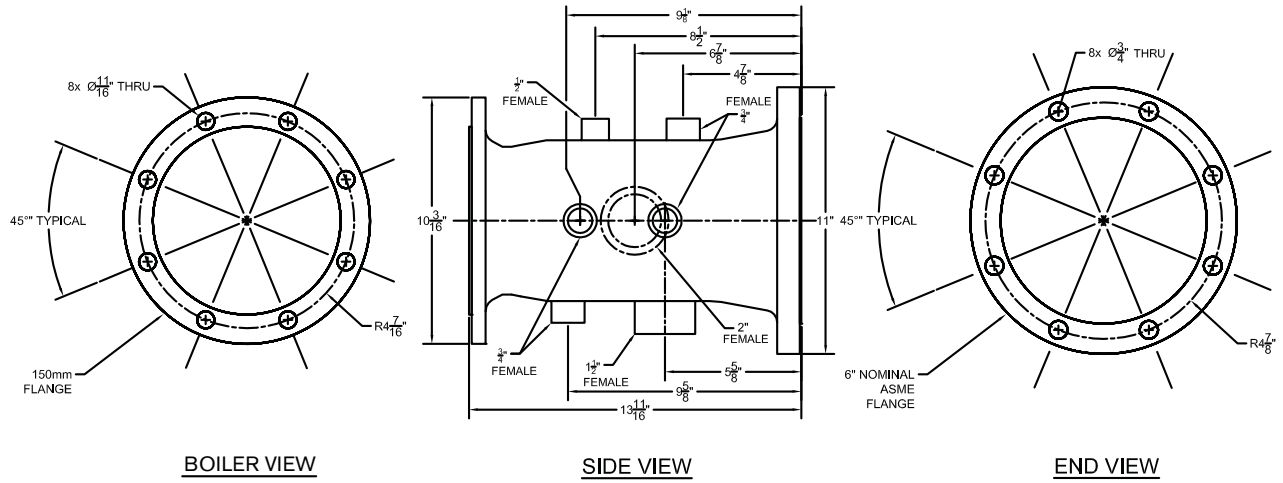

Return Manifold Connections

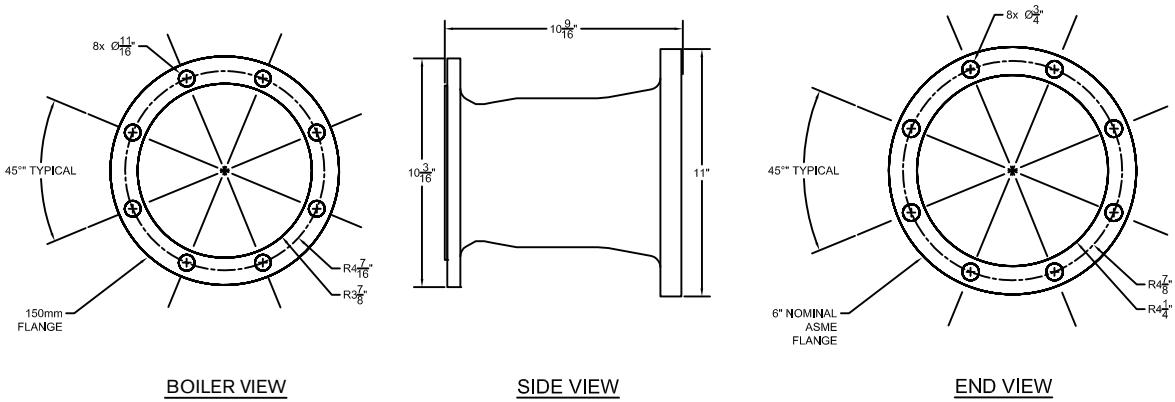

Boiler Clearances

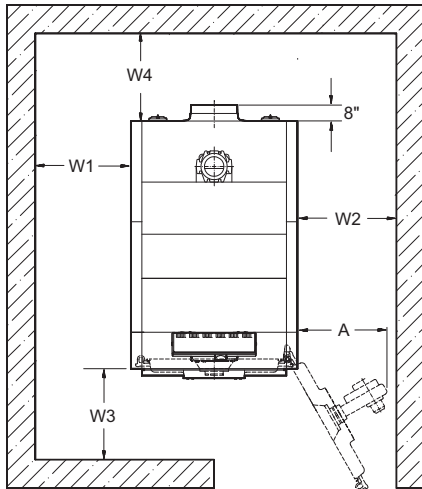

Top View

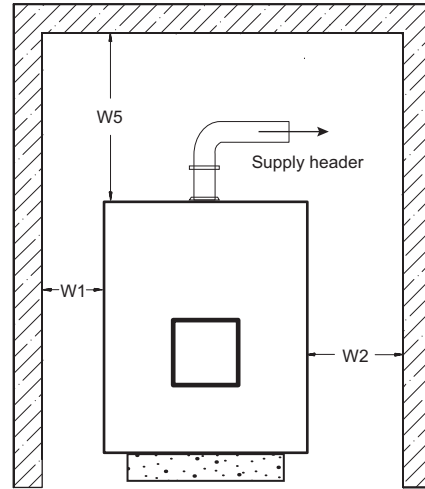

Front View

*) Requires removal of burner for fully opening burner door.
**) May require use of segmented brush for cleaning.

Description	Unit	Recommended clearance (minimum clearance)
Wall clearance W1	Inch	32 (12)
Wall clearance W2	Inch	burner length A + 4 (12*)
Wall clearance W3	Inch	boiler length + 40 (60**)
Wall clearance W4	Inch	½ boiler length + 20 (32)
Wall clearance W5	Inch	24 (24)

DISCLAIMER

Bosch Thermotechnology Corp. makes no warranty or representation, expressed or implied, with respect to the accuracy, completeness, or usefulness of this information, nor assumes any liability with respect to the use of any information contained within this document.